

Model Code/s:

EDW6CS

Product:

**Freestanding
Dishwasher**

Document:

User Manual

Esatto



Dear Customer,

Congratulations on purchasing your dishwasher. The *Esatto* brand is proudly distributed within Australia by Residentia Group Pty Ltd.

Please refer to the warranty card at the rear of this manual for information regarding your product's parts and labour warranty, or visit us online at www.residentiagroup.com.au.

At Residentia Group, we are customer obsessed and our Support Team are there to ensure you get the most out of your appliance. Should you want to learn more about the various dishwasher functions, or even checking to ensure your crockery is suitable for your dishwasher, our Support Team are here to help.

You can use our online Support Centre at anytime by visiting <http://support.residentiagroup.com.au>, or you can contact us via phone by dialling: 1300 11 HELP (4357).

It is important that you read through the following use and care manual thoroughly to familiarise yourself with the installation and operation requirements of your appliance to ensure optimum performance.

Again, thank you for choosing an *Esatto* appliance and we look forward to being of service to you.

Kind Regards,
The Residentia Team



User Manual:

Esatto

Contents:

	Page:
Safety instructions	04
Your Dishwasher	06
Installation Instructions	07
Operating Your Dishwasher	11
Cleaning & Maintenance	18
Troubleshooting	21
Technical Data	21
Warranty Information	24
Purchase Details	26
Receipt	27



Safety Instructions

This dishwasher is intended to be used in domestic environments only, including:

- household kitchen;
- staff/office kitchen;
- hotel/motel kitchens; or
- bed and breakfast type environments.

It has not been designed for use in commercial kitchen environments.

Warning Please ensure that you carefully read this user manual before installing and using the dishwasher, as it will help you to use and maintain the dishwasher properly.

- Keep it as a reference for the future as it also contains your product warranty card.
- Pass this user manual on to any subsequent owners of the appliance.

Important! The electricity supply to the dishwasher must be cut off before any adjustments or maintenance work is undertaken.

- This dishwasher must be grounded. In the event of a malfunction or product failure, grounding will reduce the risk of an electric shock by providing a path of least resistance of electric current.
- The plug must be plugged into an appropriate outlet that is installed and grounded in accordance with all local codes.

Warning Improper connection of the equipment-grounding conductor can result in the risk of an electric shock. Check with a qualified electrician or service representative if you are in doubt as to whether your dishwasher is grounded properly. Never modify the plug supplied with the appliance. If the plug doesn't fit the outlet, have a licenced and suitably qualified electrician install the correct outlet.

- Do not abuse, sit on, or stand on the door or dish rack of the dishwasher.
- Do not touch the heating element during or immediately after use. (This instruction is only applicable to machines with a visual heating element.)
- Do not operate your dishwasher unless all enclosure panels are properly in place. Open the door very carefully if the dishwasher is operating, there is a risk of water squirting out.
- Do not place any heavy objects on or stand on the door when it is open. The appliance could tip forward.
- When loading items to be washed:
 - 1) Locate sharp items so that they are not likely to damage the door seal;
 - 2) Warning: Knives and other utensils with sharp points must be loaded in the basket with their points down or placed in a horizontal position.
- When using your dishwasher, you should prevent plastic items from coming into contact with the heating element. (This instruction is only applicable to machines with a visual heating element.)
- Check that the detergent compartment is empty after completion of the wash cycle.
- Do not wash plastic items unless they are marked dishwasher safe or the equivalent. For plastic items not so marked, check the manufacturer's recommendations.
- Use only detergent and rinse additives designed for an automatic dishwasher.
- Never use soap, laundry detergent, or hand-washing detergent in your dishwasher. Keep these products out of the reach of children.
- Keep children away from detergent and rinse. Always be sure to keep the dishwasher door closed with children around, as there may still be residual detergent inside.

- This appliance is not intended for use by persons (including children with reduced physical, sensory or mental capabilities, or lack of experience and knowledge, unless they have been given supervision or instruction concerning use of the appliance by a person responsible for their safety.)
- Children should be supervised to ensure that they do not play with the appliance.
- The door should not be left open, since this could increase the risk of tripping.
- If the supply cord is damaged, it must be replaced by the manufacturer or its service agent or a similarly qualified person in order to avoid a hazard.
- Remove the door to the washing compartment when removing an old dishwasher from service or discarding it.
- During installation, the power supply must not be excessively or dangerously bent or flattened.
- The appliance is to be connected to the water mains using new hose sets and that old hose-sets should not be reused.
- The maximum number of place settings to be washed is 14.
- The maximum permissible inlet water pressure is 1Mpa.
- The minimum permissible inlet water pressure is 0.04Mpa.
- Never use an extension cord.
- It's recommended to provide a separate circuit to serve your dishwasher alone and you should use the required 10 amp fuse.
- An extension hose can be used but should be no longer than 4 meters, otherwise the performance of the dishwasher will be effected.

DECLARATION OF CONFORMITY

- The manufacturer declares that the dishwasher is built using certified materials and requires the appliance to be installed in accordance with the standards currently in force. This appliance must be used by a trained person for domestic purposes only.

UNPACKING

- During transportation, protective packaging was used to protect the appliance against any damage. After unpacking, please dispose of all elements of packaging in a way that will not cause damage to the environment. All materials used for packaging the appliance are environmentally friendly; they are 100% recyclable and are marked with the appropriate symbol.
- During unpacking, the packaging materials (polythene bags, polystyrene pieces, etc.) should be kept out of reach of children.

DISPOSAL OF THE APPLIANCE

- Old appliances should not simply be disposed of with normal household waste, but should be delivered to a collection and recycling centre for electric and electronic equipment. A symbol shown on the product, the instruction manual or the packaging shows that it is suitable for recycling.
- Materials used inside the appliance are recyclable and are labelled with information concerning this. By recycling materials or other parts from used devices you are making a significant contribution to the protection of our environment.
- Information on appropriate disposal centres for used devices can be provided by your local authority.

Your Dishwasher

SPECIFICATIONS

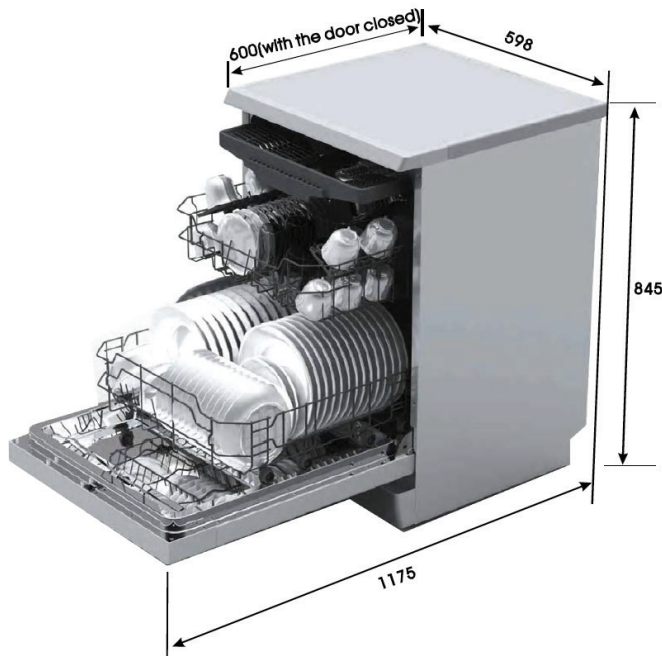

Front view

Back View

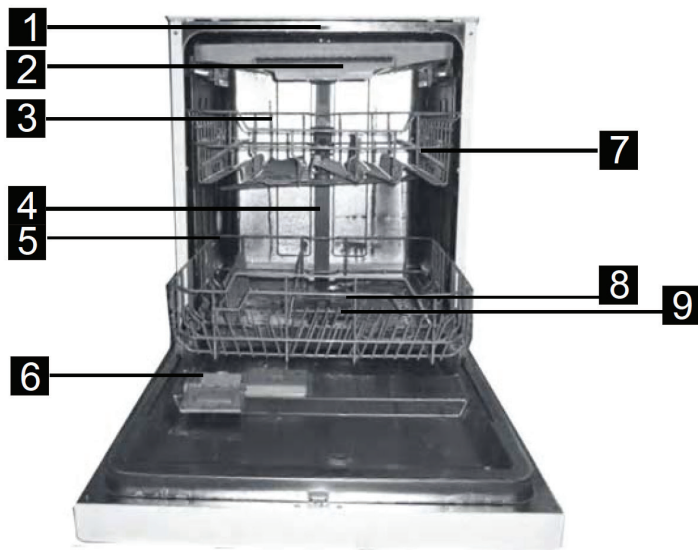

- 1. Top Spray Arm
- 5. Lower Basket
- 9. Filter assembly

- 2. Cutlery Rack
- 6. Dispenser
- 10. Inlet pipe connector

- 3. Upper Basket
- 7. Cup Shelf
- 11. Drain Pipe

- 4. Inner Pipe
- 8. Spray Arms

MODEL	PRODUCT DIMENSIONS (WxDxH)	PRODUCT FEATURES
EDW6CS	598 × 600 × 845mm	<ul style="list-style-type: none"> ● 14 Place setting capacity ● Upper slide-out cutlery tray ● Mark-free stainless steel door

Installation Instructions

It's important to carefully read the following installation instructions before beginning the installation of your dishwasher.

Important! The installation of the pipes and electrical outlets should be completed by suitably licensed and qualified persons.

POSITIONING

- The installation position of the dishwasher should be near the existing inlet, drainage wastepipe and power outlet.
- Choose a position near your sink to facilitate the installation of inlet and drain hoses (refer to figure one).
- If the dishwasher is installed in the corner of your kitchen cabinetry, make sure an allowance is made to ensure your dishwasher door can freely open without obstruction from other cabinetry/door handles.

1

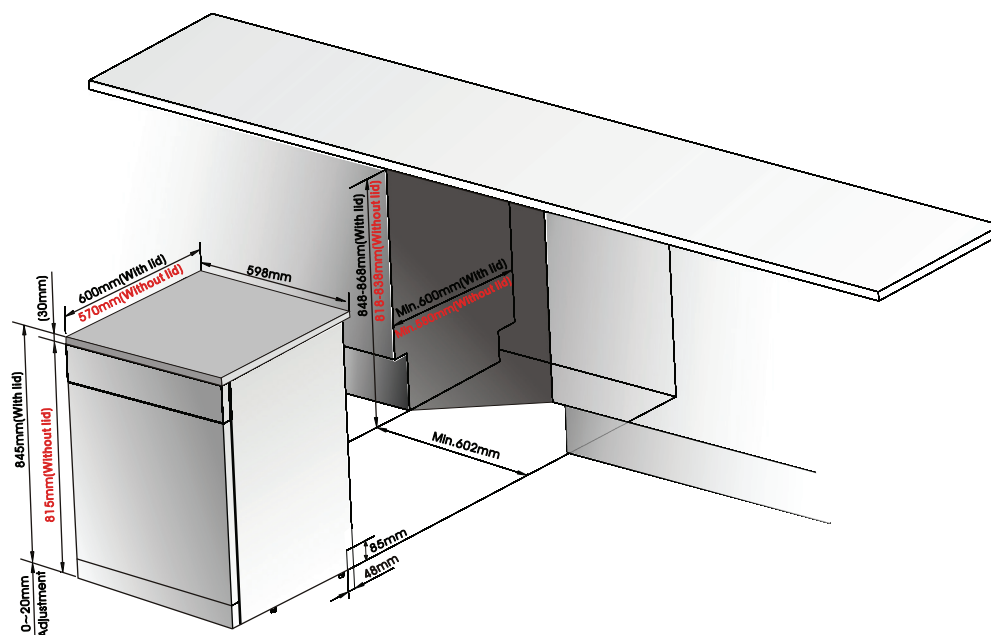

Figure 1\ Cabinet dimensions:
 Less than 5mm between the top of dishwasher and cabinet and the outer door aligned to cabinet.

2

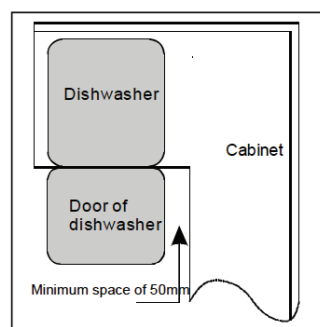

Figure 2\ Minimum space when the door is opened.

COLD WATER CONNECTION

- Connect the cold water supply hose to a threaded 3/4(inch) connector and make sure that it is fastened tightly in place.
- If the water pipes are new or have not been used for an extended period of time, let the water run to make sure that the water is clear. This precaution is needed to avoid the risk of the water inlet to be blocked and damage the appliance.

CONNECTION OF THE DRAIN HOSE

- Insert the drain hose into a drain pipe with a minimum diameter of 40mm, or connect it onto the trap of your sink where a dishwasher connection is present.

Important! The top of the hose must be less than 1000mm, as illustrated below.

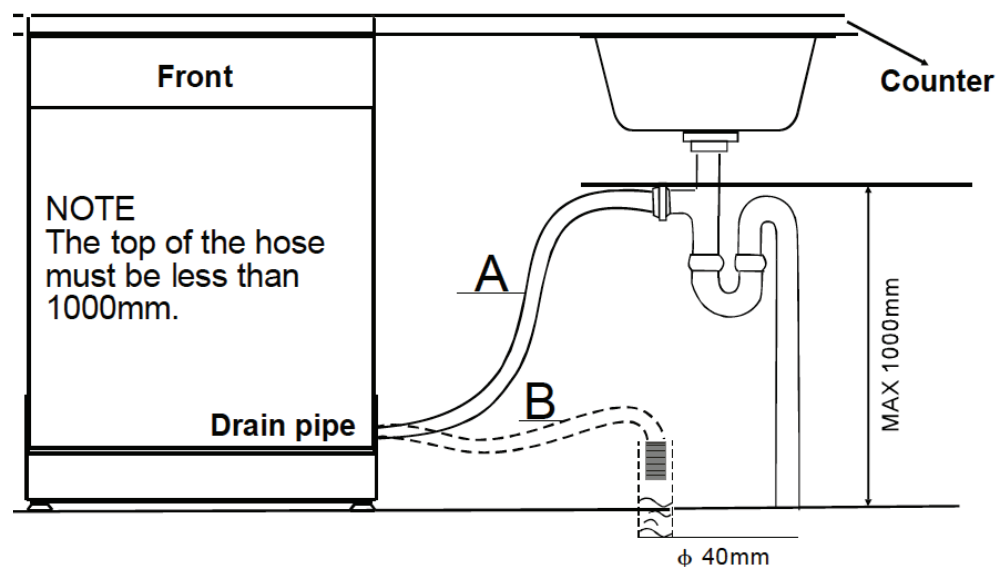

Note: If you require a longer drain hose, make sure you use a similar drain hose. It must be no longer than 4 metres; otherwise the performance of the dishwasher will be effected.







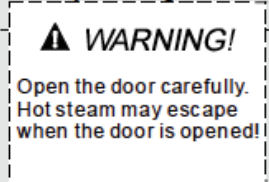
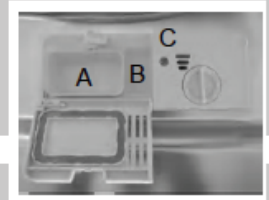

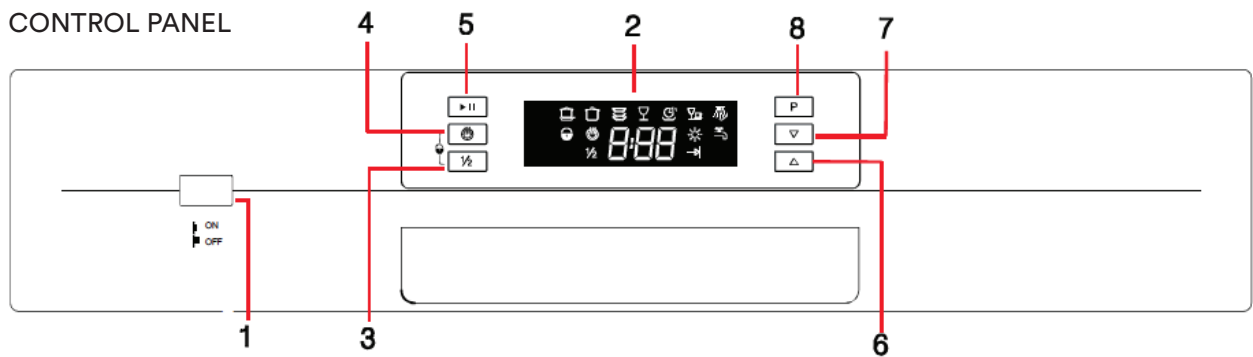
Operating Your Dishwasher

QUICK OPERATION GUIDE

Switch on the appliance	Press the On/Off button to switch on the appliance, Open the door.
Fill the detergent dispenser	<p>Compartment A: With each wash cycle.</p> <p>Compartment B: For programmes with pre-wash only. (Follow the User Manual!)</p>
Check the rinse aid level	<p>Mechanical indicator C. Electric indicator on control panel (if provided).</p>
Load the baskets	Scrape off any large amount of leftover food. Soften remnants of burnt food in pans, then load the baskets. Refer to the dishwasher loading instructions.
Select a programme	Close the door, press the Programme Button until the selected programme lights up. (See the section entitled "Operation instruction")
Running the dishwasher	Turn on the water tap and press the Start/Pause Button. The machine will start working after about 10 seconds.
• Changing the programme	<p>1. A running cycle can only be modified if it has been running for a short time. Otherwise the detergent may have already been released and the water already drained. If this is the case, the detergent dispenser must be refilled.</p> <p>2. Press the Start/Pause button, press the program button for more than three seconds, the machine will be in standby state, then you can change the program to the <u>desired cycle setting</u></p>
• Add forgotten dishes in the dishwasher.	<p>1. Press the Start/Pause Button to stop the washing.</p> <p>2. Open the door a little .</p> <p>3. After the spray arms stop working, you can open the door completely.</p> <p>4. Add forgotten dishes.</p> <p>5. Close the door.</p> <p>6. Press the Start/Pause Button, the dishwasher will run after 10 seconds.</p>
• If the appliance is switched off during a wash cycle.	If the appliance is switched off during a wash cycle, when switched on again, please re-select the washing cycle and operate the dishwasher according to the original Power-on state.
Switch off the appliance	When the working cycle has finished, the buzzer of the dishwasher will sound 8 times, then stop. Turn off the appliance using the On/Off Button.
Turn off the water tap, unload the baskets	Warning: wait a few minutes (about 15 minutes) before unloading the dishwasher to avoid handling the dishes and utensils while they are still hot and more susceptible to break. They will also dry better. Unload the appliance, starting from the lower basket.





1. On/Off Button: to switch On/Off the appliance.
2. Display screen: to show the remaining time and the state (running state, delay time etc)
 Program indicators : 
 → To show the selected washing program.
 →  Child Lock indicator : To show when Child Lock function is selected.
 →  Extra Dry indicator : To show when Extra dry function is selected.
 →  Half Load function indicator: To show when half load function is selected.
 →  Rinse aid indicator : To show when the rinse aid need to be refilled.
 →  Faucet indicator : To show when the faucet forget to open.
 →  Washing cycle finished indicator : To show when the washing cycle is finished.
 →  **8:88** To show the delay time, remain time and error code.
3. Half load function Button: To select Half load function. When Half load function is selected, both sprayers will be running and all baskets could be loaded.
4. Extra Drying function select Button: To select Extra Drying function. An increased temperature during the final rinse to increase drying well. There is a slight increase in the energy consumption.
5. Start /Pause button: To start the selected washing program or pause the washing program when the machine is working.
6. Delay Button : Press the button to add the delay time.
7. Delay Button : Press the button to decrease the delay time.
8. Program Button : To Press the button to select appropriate Program.

Attention: Child lock function: press the Extra dry button and the Half load button simultaneously to lock the operation, the same way to unlock.

FILLING THE RINSE AID DISPENSER

The rinse aid is released during the final rinse to prevent water from forming droplets on your dishes, which can leave spots and streaks. It also improves drying by allowing water to roll off the dishes. Your dishwasher is designed to use liquid rinse aids. The rinse aid dispenser is located inside the door next to the detergent dispenser. To fill the dispenser, open the cap and pour the rinse aid into the dispenser until the level indicator turns completely black. The volume of the rinse aid container is about 110ml.

Warning! Only use specific "Rinse Aid" branded products and never fill the rinse aid dispenser with other substances and they may damage the dishwasher.

→ If there is no rinse-aid warning light in the control panel, you can judge the amount of rinse-aid by the color of the optical level indicator "C" located next to the cap. When the rinse-aid container is full, the whole indicator will be dark. As the rinse-aid diminishes, the size of the dark dot decreases. You should never let the rinse aid get below 1/4 full.

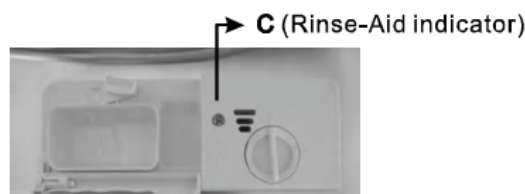



- To open the dispenser, turn the cap to the "open" arrow, anti-clockwise, and lift out. (1)
- Pour the rinse aid into the dispenser, being careful not to overfill. (2)
- Replace the cap by inserting it aligned with the "open" arrow and turn clockwise. (3)

Warning! Be careful not to overfill the dispenser and wipe up any excess spilt with a damp cloth. Any residual rinse aid can cause excess foaming during the next wash.

ADJUSTING THE RINSE AID DISPENSER

- The rinse aid dispenser has six or four settings. Always start with the dispenser set on "4". If spots and poor drying are a problem, increase the amount of rinse aid dispensed by removing the dispenser lid and rotating the dial to "5". If the dishes are still not drying properly or are showing spots, adjust the dial to the next higher lever until your dishes are spot-free. The recommended setting is "4". (Factory value is "4".)

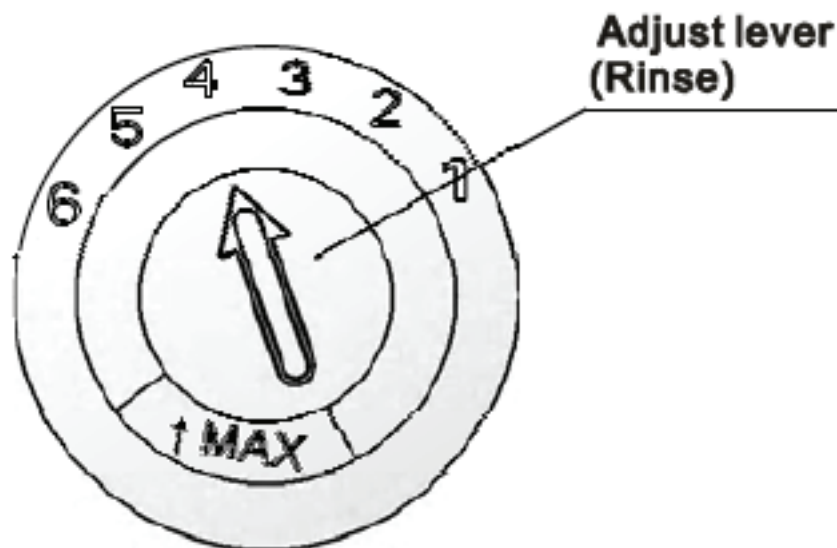

- Increase the dose of rinse aid if there are drops of water or lime spots on the dishes after washing. Reduce it if there are sticky whitish stains on your dishes or a film on your glassware or cutlery.

DETERGENTS

Detergents with its chemical ingredients are necessary to remove dirt, crush dirt and transport it out of the dishwasher. Most of the commercial quality detergents are suitable for this purpose.

- If the lid is closed, press the release button and the lid will spring open.
- Always add the detergent just before starting each wash cycle.
- Only use branded detergent and rinse aid with your dishwasher.

Warning! Dishwasher detergent is corrosive! Take care to keep it out of reach of children.

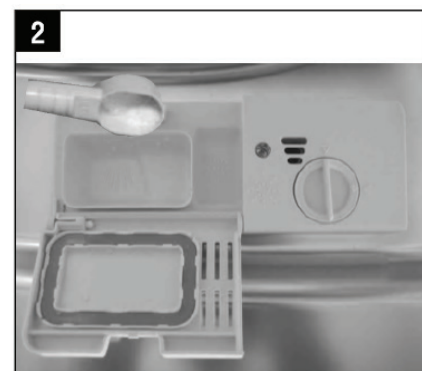
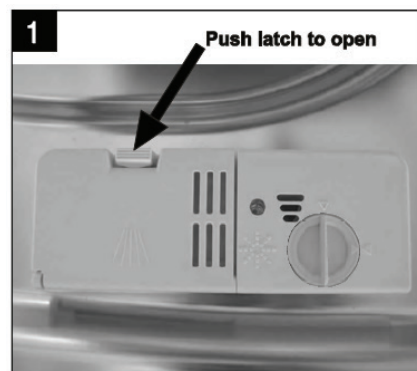
**FILLING YOUR DETERGENT DISPENSER**

- Compartment A (below) is for the main wash cycle detergent.
- Compartment B is for the pre-wash cycle detergent. This can be used for heavily soiled dishes.
- In regards to dosage, follow the instructions of the detergent manufacturer.
- Close the lid by pressing until it locks into place.

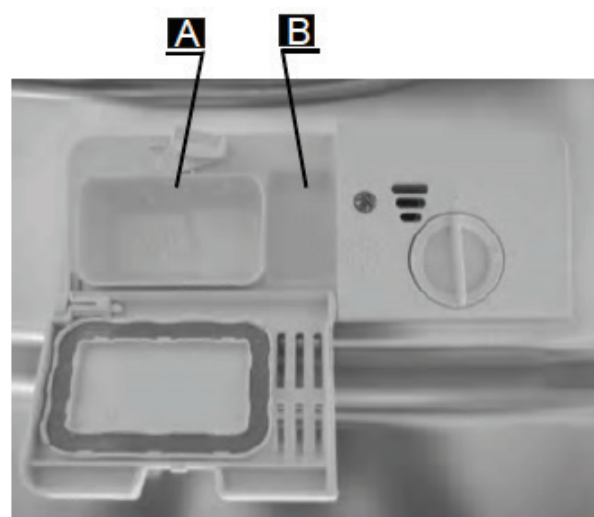

LOADING THE DISHWASHER

Only use utensils and dishes that are identified as dishwasher safe or proof.

- To prevent damage to your dishes and glassware, do not remove them from the dishwasher immediately after the program has ended.

Items that are not suitable for the dishwasher:

- Cutlery with wooden, china, or mother of pearl handles
- Plastic items that are not heat resistant
- Older cutlery with glued parts
- Pewter or copper items
- Crystal glass
- Steel items that are subject to rusting
- Wooden platters
- Items made from synthetic fibres

Items that are of limited suitability for the dishwasher:

- Some types of glassware can become dull after a large number of washes
- Silver and aluminium parts have a tendency to discolour during washing
- Glazed patterns may fade after a large number of washes
- Scrape off any residual food and soften remnants of burnt food in pans, before placing in your dishwasher.
- Whilst it is not necessary to rinse the dishes under running water, heavily soiled dishes are recommended to be rinsed first.
- Items such as cups, glasses, pots/pans etc are faced downwards.
- Curved items, or ones with recesses, should be loaded on an angle so that water can run off.
- Ensure that no dishes interfere in the operation of the spray arms, and that they can freely rotate during washing.

Warning! Very small items should never be washed in the dishwasher as they could easily fall out of the baskets/racks.

- Place large items which are most difficult to clean, in the bottom rack.
- Place delicate and lighter dishwasher (such as glasses, mugs, etc) into the upper rack.
- Ensure that glasses are not touching to prevent damage.

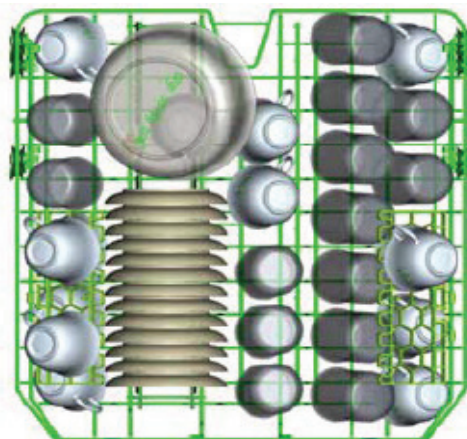

Upper Rack Example

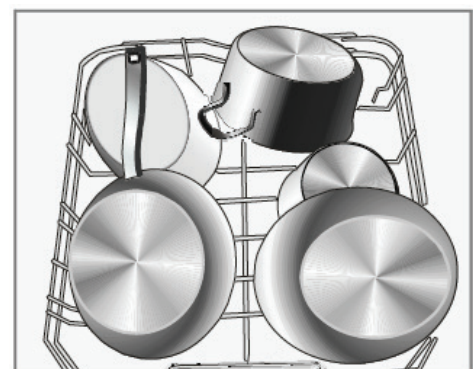

Lower Rack Example

ADJUSTING THE UPPER BASKET

The height of the upper basket can be adjusted in order to create more space for large dishes both for the upper and lower basket racks. The height of the upper basket rack can be adjusted by lifting up the basket for the upper position, and lifting up the handle to lower the basket, see the picture below:

Lift the basket for upper position



Lift up the handle to lower the basket



Adjust the Handle

FOLDING BACK THE CUP SHELVES

For better stacking of pots and pans, the spikes can be folded down as shown in the picture below.

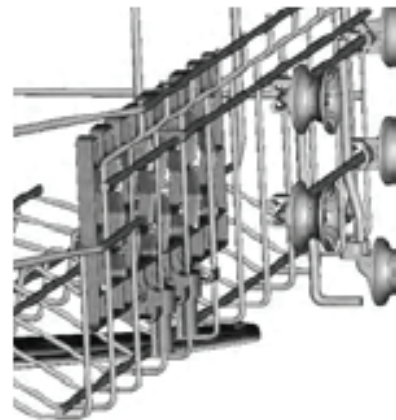
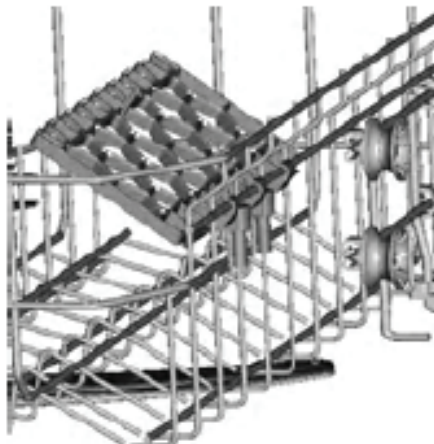

FOLDING SPIKES OF LOWER BASKET

For improved stacking of pots or pans, the spikes can be folded down as shown in the picture below.



CUTLERY BASKET

Cutlery should be placed in the cutlery rack separately from each other in the appropriate positions, and do make sure the utensils do not nest together.

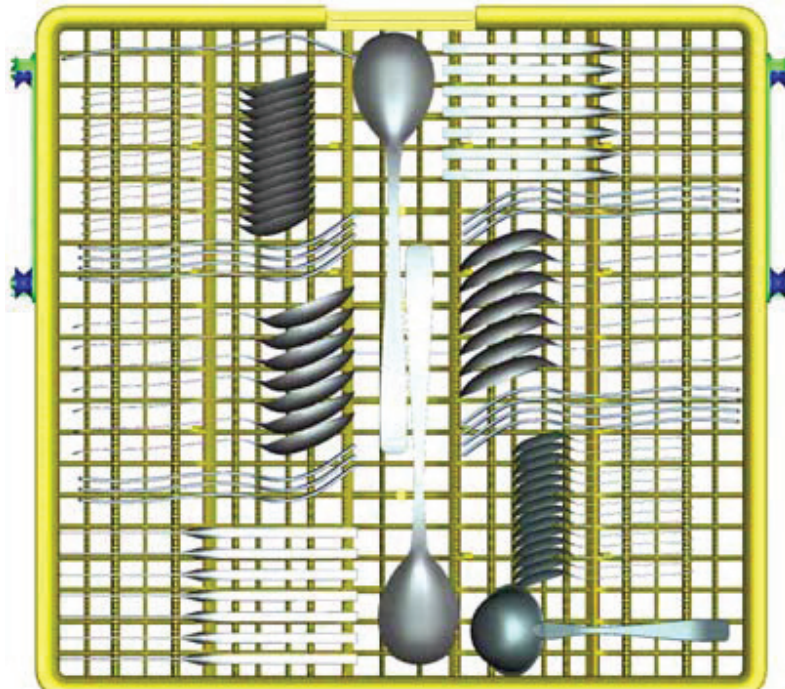
**STARTING A WASH CYCLE**

- Load the cutlery and dish basket racks.
- Add your detergent and rinse aid if required.
- With the dishwasher door open, press the Power Button and the Power Indicator light will turn on.
- Press the Program Button and the Wash Program indicator will rotate between Intensive, Heavy, Normal, Glass, 1 Hour, Rapid.
- Select any additional Options, such as Half Load or Extra Dry if desired.
- Once your desired wash program is selected, close the door and the dishwasher will start it's cycle.







Note: A cycle that is underway can only be modified if it has only been running for a short time. To enter standby mode during a cycle, open the door and hold the Program button for 3 or more seconds. If the door is opened during a cycle, the dishwasher will pause momentarily and a buzzer will sound every minute until you close the door. Once closed, the dishwasher will begin to operate again after 10 seconds.

AT THE COMPLETION OF A WASH CYCLE

Once the dishwasher cycle has finished, the dishwasher will make an audible tone for 8 seconds, before stopping.

- Turn off the dishwasher using the Power Button.
- Open the dishwasher door and wait a few minutes before unloading the dishwasher. This will allow the dishes to climatise and return to a cool state for handling.

STARTING A WASHING PROGRAM

Program	Cycle Selection Information	Description of Cycle	Detergent pre/main	Running time(min)	Energy (Kwh)	Water (L)	Rinse Aid
Intensive 	For the heaviest soiled loads, such as pots, pans, casserole dishes and dishes that have been sitting with dried food on them for a while.	Pre-wash(50°C) Wash (65 °C) Rinse Rinse Rinse(65°C) Drying	<i>5/27.5g</i> <i>(Or All in 1)</i>	135	1.4	18	★
Heavy 	For heavily soiled loads, such as pots, plates, glasses and lightly soiled pans.	Pre-wash(45 °C) Wash (55 °C) Rinse Rinse (60 °C) Drying	<i>5/27.5g</i> <i>(Or All in 1)</i>	165	1.15	14.5	★
Normal  <small>(*AS/NZS 2007.1)</small>	For normally soiled loads, such as pots, plates, glasses and lightly soiled pans. standard daily cycle.	Pre-wash Wash (50 °C) Rinse Rinse(50°C) Drying	<i>5/27.5g</i> <i>(Or All in 1)</i>	160	0.87	13.6	★
Glass 	For lightly soiled loads, such as glasses, crystal and fine china.	Pre-wash wash(40°C) Rinse Rinse(60°C) Drying	20g	115	0.8	14.5	★
1 Hour 	Daily wash in only 1 hour. For lightly and normally soiled plates and pans for everyday.	Pre-wash(50°C) Wash(60°C) Rinse (55°C) Drying	<i>5/27.5g</i>	60	0.9	10	★
Rapid 	A shorter wash for lightly soiled loads that do not need drying.	Wash (40 °C) Rinse Rinse (45 °C)	20g	40	0.5	10.5	
Soak 	To rinse dishes that you plan to wash later that day.	Pre-wash		8	0.01	3.8	

Cleaning & Maintenance

FILTERING SYSTEM

The filter prevents larger remnants of food or other objects from getting inside the pump. The residues may block the filter, in this case they must be removed.

The filter system consists of a coarse filter, a flat (main filter) and a microfilter (fine filter).

- Main Filter (1): Food and soil particles trapped in this filter are pulverised by a special jet on the lower spray arm and washed down to the drain.
- Coarse Filter (2): Larger items, such as pieces of bones or broken glass that could block the drain are trapped in the coarse filter. To remove the items caught by the filter, gently squeeze the tap on the top of this filter and lift out.
- Fine Filter (3): This filter holds soil and food residues in the sump area and prevents it from being redeposited on to the dishes during the wash cycle.

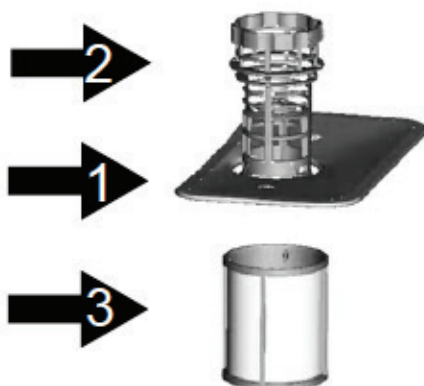

FILTER ASSEMBLY

Important! The dishwasher must never be used without the filters. Improper replacement of the filter may reduce the performance of the dishwasher and could damage dishes and utensils.

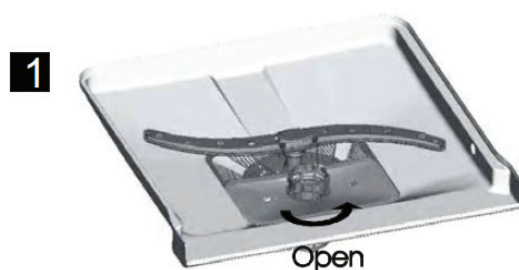

Step 1.
Turn the filter in
anti-clockwise direction



Step 2.
Lift the filter assembly up

- Inspect the filter assembly after each use of the dishwasher, for any blocks. Remove the filter system and clean the filters under running water, removing any food remnants.

CARING FOR THE DISHWASHER

- The control panel of the dishwasher can be cleaned using a slightly dampened cloth. After cleaning, ensure it is dried thoroughly.
- To clean the internal edge of the door, you should only use a soft, damp cloth with warm water. Avoid using any spray cleaners as these can penetrate into the door lock and electrical components.

CLEANING THE SPRAY ARMS

- It is necessary to clean the spray arms regularly for hard water chemicals will clog the spray arm jets and bearings.
- To remove the upper spray arm, hold the nut and rotate the arm clockwise to remove.
- To remove the lower spray arm, pull the spray arm upwards (as per the diagram below).

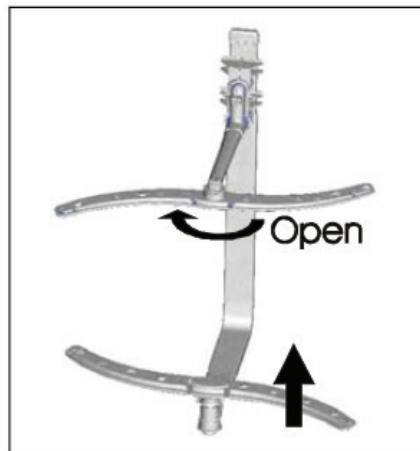

- Wash the arms in warm soapy water and use a brush to clean the jets. Replace the spray arms after rinsing thoroughly.

GENERAL CARE INSTRUCTIONS FOR YOUR DISHWASHER

- After every wash, leave the door slightly open so that moisture and odours are not trapped inside.
- Before performing maintenance or cleaning, always switch off at the power outlet and remove the plug.
- To clean the exterior and rubber door seals of the dishwasher, never use solvents or abrasive cleaning products. Warm soapy water should always be sufficient, or for stubborn stains only use specialty cleaning products specifically made for dishwashers.
- When your dishwasher won't be used for a long period of time, it is recommended that you run a wash cycle with the dishwasher empty and then leave the dishwasher door slightly open. Also unplug the dishwasher from the power socket.
- When moving the appliance, always try to ensure it is kept in the vertical position. If absolutely necessary, it can be positioned on its back.
- One of the factors that can cause odours to form is residual food that remains trapped in the seals. Periodic cleaning with a soft damp cloth (as described above) will prevent this from occurring

Troubleshooting & Technical Data

OPERATION IN CASE OF EMERGENCY

Important! If your dishwasher appears to be operating incorrectly, then you should disconnect it from the power outlet and then contact the Residentia Group Support team on 1300 11 HELP (4357).

In the event of an emergency you should:

- Switch off the dishwasher at the controls.
- Switch off the dishwasher at the power outlet and remove the plug.
- Isolate the water supply from the dishwasher.
- Call the Residentia Support Team on 1300 11 HELP (4357).

Troubleshooting Some minor faults can be fixed by referring to the instructions given below. There is also a self-help section online at <http://www.residentia.com.au>.



	Problem	Possible Causes	What To Do
Technical problems	<i>Dishwasher doesn't start</i>	Fuse blown, or the home circuit breaker has been triggered.	Replace fuse or reset circuit breaker. Remove any other appliances sharing the same circuit with the dishwasher.
		Power supply is not turned on	Make sure the dishwasher is turned on and the door is closed securely. Make sure the power cord is properly plugged into the wall socket.
		Error code: E1; Water pressure is low	Check that the water supply is connected properly and the water is turned on.
	<i>water not pumped from dishwasher</i>	Door of dishwasher not properly closed.	Make sure to close the door properly and latch it.
		Kink in drain hose	Check drain hose.
		Filter clogged	Check the filter (see section titled "Cleaning The Filter")
General problems	<i>Suds in the tub</i>	Kitchen sink clogged	Check the kitchen sink to make sure it is draining well. If the problem is the kitchen sink not draining, you may need a plumber rather than a serviceman for dishwashers.
		Improper detergent	Use only the special dishwasher detergent to avoid suds. If this occurs, open the dishwasher and let suds evaporate. Add 1 gallon of cold water to the tub. Close and latch the dishwasher, then select any cycle. Dishwasher will drain out the water at the first step. Open the door after the draining has stopped and check if the suds have disappeared. Repeat if necessary.
	<i>Stained tub interior</i>	Spilled rinse-aid	Always wipe up rinse-aid spills immediately.
		Detergent with colourant was used	Make sure that the detergent is the one without colourant.
		Hard water minerals	To clean the interior, use a damp sponge with dishwasher detergent and wear rubber gloves. Never use any other cleaner than dishwasher detergent for the risk of foaming or suds.
<i>White film on inside surface</i>			
<i>There are rust stains on cutlery</i>	The affected items are not corrosion resistant.	The items should be corrosion resistant.	

Noise	<i>Knocking noise in the wash cabinet</i>	A spray arm is knocking against an item in a basket	Interrupt the programme, and rearrange the items which are obstructing the spray arm.
	<i>Rattling noise in the wash cabinet</i>	Items of crockery are loose in the wash cabinet	Interrupt the programme, and rearrange the items of crockery.
	<i>Knocking noise in the water pipes</i>	This may be caused by on-site installation or the cross-section of the piping.	This has no influence on the dishwasher function. if in doubt, contact a suitably qualified plumber.
Unsatisfactory washing result	<i>The dishes are not clean</i>	The dishes were not loaded correctly.	See notes in " Loading the Dishwasher Baskets ".
		The programme was not powerful enough.	Select a more intensive programme. See" Wash Cycle Table ".
		Not enough detergent was dispensed.	Use more detergent, or change your detergent.
		Items are blocking the path of spray arms.	Rearrange the items so that the spray can rotate freely.
		The filter combination in the base of wash cabinet is not clean or is not correctly fitted. This may cause the spray arm jets to get blocked.	Clean and/or fit the filter combination correctly. Clean the spray arm jets. See "Cleaning the Spray Arms".
	<i>Cloudiness on glassware</i>	Combination of soft water and too much detergent.	Use less detergent if you have soft water and select a shortest cycle to wash the glassware and to get them clean.
	<i>Black or gray marks on dishes</i>	Aluminum utensils have rubbed against dishes.	Use a mild abrasive cleaner to eliminate those marks.
<i>Detergent left in dispenser cups</i>	Dishes block detergent cups.	Re-loading the dishes properly.	
Unsatisfactory drying result	<i>The dishes are not drying</i>	Improper loading	Load the dishwasher as suggested in the directions.
		Too little rinse-aid	Increase the amount of rinse-aid/refill the rinse-aid dispenser.
		Dishes are removed too soon	Do not empty your dishwasher immediately after washing. Open the door slightly so that the steam can escape. Begin unloading the dishwasher only once the dishes are barely warm to the touch. Empty the low basket first. This prevents water from dropping off dishes in the upper basket.
		Wrong program has been selected	In short program the washing temperature is lower. This also lowers cleaning performance. Choose a program with a long washing time.
	Use of cutlery with a low-quality coating	Water drainage is more difficult with these items. Cutlery or dishes of this type are not suitable for washing in the dishwasher.	

ERROR CODES

When some malfunctions occur, the dishwasher may display some error codes to warn you of an issue.

<i>Codes</i>	<i>Meanings</i>	<i>Possible Causes</i>
E1	Longer inlet time.	Faucets is not opened, or water intake is restricted, or water pressure is too low.
E4	Overflow.	Some element of dishwasher leaks .

TECHNICAL DATA

Electrical details	Rated Voltage: 220 - 240 Volts, 50 Hz
Capacity:	14 Place Settings
Water Pressure:	0.04-1.0 MPa

Warranty

WARRANTY TERMS & CONDITIONS DISHWASHERS (FREESTANDING, INTEGRATED)

→ This document sets out the terms and conditions of the product warranties for Residentia Group Appliances. It is an important document. Please keep it with your proof of purchase documents in a safe place for future reference should you require service for your Appliance.

1. In this warranty
 - (a) 'acceptable quality' as referred to in clause 10 of this warranty has the same meaning referred to in the ACL;
 - (b) 'ACL' means Trade Practices Amendment (Australian Consumer Law) Act (No.2) 2010;
 - (c) 'Appliance' means any Residentia Group product purchased by you accompanied by this document;
 - (d) 'ASR' means Residentia Group authorised service representative;
 - (e) 'Residentia Group' means Residentia Group Pty Ltd of 20 Yaltara Avenue, Bundoora Victoria 3083, ACN 600 546 656 in respect of Appliances purchased in Australia;
 - (f) 'major failure' as referred to in clause 10 of this warranty has the same meaning referred to in the ACL and includes a situation when an Appliance cannot be repaired or it is uneconomic for Residentia Group, at its discretion, to repair an Appliance during the Warranty Period;
 - (g) 'Warranty Period' means:
 - (i) where the Appliance is used for personal, domestic or household use (i.e. normal single family use) as set out in the instruction manual, the Appliance is warranted against manufacturing defects in Australia for 12 months following the date of original purchase of the Appliance;
 - (h) 'you' means the purchaser of the Appliance not having purchased the Appliance for re-sale, and 'your' has a corresponding meaning.
2. This warranty only applies to Appliances purchased and used in Australia and is in addition to (and does not exclude, restrict, or modify in any way) any non-excludable statutory warranties in Australia.
3. During the Warranty Period Residentia Group or its ASR will, at no extra charge if your Appliance is readily accessible for service, without special equipment and subject to these terms and conditions, repair or replace any parts which it considers to be defective. Residentia Group or its ASR may use remanufactured parts to repair your Appliance. You agree that any replaced Appliances or parts become the property of Residentia Group. This warranty does not apply to light globes, batteries, filters or similar perishable parts.
4. Parts and Appliances not supplied by Residentia Group are not covered by this warranty.
5. You will bear the cost of transportation, travel and delivery of the Appliance to and from Residentia Group or its ASR. If you reside outside of the service area, you will bear the cost of:
 - (a) travel of an authorised representative;
 - (b) transportation and delivery of the Appliance to and from Residentia Group or its ASR, in all instances, unless the Appliance is transported by Residentia Group or its ASR, the Appliance is transported at the owner's cost and risk while in transit to and from Residentia Group or its ASR.
6. Proof of purchase is required before you can make a claim under this warranty.

Warranty continued

7. You may not make a claim under this warranty unless the defect claimed is due to faulty or defective parts or workmanship. Residentia Group is not liable in the following situations (which are not exhaustive):
- (a) the Appliance is damaged by:
 - (i) accident
 - (ii) misuse or abuse, including failure to properly maintain or service
 - (iii) normal wear and tear
 - (iv) power surges, electrical storm damage or incorrect power supply
 - (v) incomplete or improper installation
 - (vi) incorrect, improper or inappropriate operation
 - (vii) insect or vermin infestation
 - (viii) failure to comply with any additional instructions supplied with the Appliance;
 - (b) the Appliance is modified without authority from Residentia Group in writing;
 - (c) the Appliance's serial number or warranty seal has been removed or defaced;
 - (d) the Appliance was serviced or repaired by anyone other than Residentia Group, an authorised repairer or ASR.
8. This warranty, the contract to which it relates and the relationship between you and Residentia Group are governed by the law applicable where the Appliance was purchased.
9. To the extent permitted by law, Residentia Group excludes all warranties and liabilities (other than as contained in this document) including liability for any loss or damage whether direct or indirect arising from your purchase, use or non use of the Appliance.
10. For Appliances and services provided by Residentia Group in Australia, the Appliances come with a guarantee by Residentia Group that cannot be excluded under the Australian Consumer Law. You are entitled to a replacement or refund for a major failure and for compensation for any other reasonably foreseeable loss or damage. You are also entitled to have the Appliance repaired or replaced if the Appliance fails to be of acceptable quality and the failure does not amount to a major failure. The benefits to you given by this warranty are in addition to your other rights and remedies under a law in relation to the Appliances or services to which the warranty relates.
11. At all times during the Warranty Period, Residentia Group shall, at its discretion, determine whether repair, replacement or refund will apply if an Appliance has a valid warranty claim applicable to it.
12. To enquire about claiming under this warranty, please follow these steps:
- (a) carefully check the operating instructions, user manual and the terms of this warranty;
 - (b) have the model and serial number of the Appliance available;
 - (c) have the proof of purchase (e.g. an invoice) available;
 - (d) telephone the numbers shown below.
13. You accept that if you make a warranty claim, Residentia Group and its ASR may exchange information in relation to you to enable Residentia Group to meet its obligations under this warranty.

IMPORTANT Before calling for service, please ensure that the steps in point 12 have been followed.

Service: Please call 1300 11 HELP (4357)

Spare Parts: Please call 1300 11 PART (7278)

Model Code/s:

EDW6CS



E2447

Residentia