

USER MANUAL

INALTO

INALTO.HOUSE

60cm Freestanding Dishwasher

MODEL CODE/S

IDW7CS



A HIGHER LEVEL OF COOKING

V1.3

Welcome!

Distributor Details

Australia Residentia Group

—
Head Office
165 Barkly Avenue
Burnley Victoria
Australia 3121

—
Online
residentia.group

—
Telephone
1300 11 HELP (4357)

—
Email
support@residentia.group

New Zealand Applico

—
Online
<http://applico.co.nz>

—
Telephone
0800 555 033

Fiji Vinod Patel

—
Online
<http://www.vinodpatel.com.fj>

—
Telephone
+679 910 3111

Other Markets

Please check with the retailer you purchased this dryer from for details of the local distributor.

Congratulations on the purchase of your InAlto dishwasher!

Please refer to the warranty card at the rear of this manual for information regarding your product's parts and labour warranty or visit us online at <http://inalto.house>.

At InAlto, we are customer obsessed and our Support Teams are there to ensure you get the most out of your appliance. Should you want to learn more about your dishwasher such as the various washing programs or importantly taking care of the appliance, our Support Team are here to help.

It is important that you read through the following use and care manual thoroughly to familiarise yourself with the installation and operation requirements of your appliance to ensure optimum performance and longevity.

Again, thank you for choosing an InAlto appliance and we look forward to being of service to you.

Regards,

InAlto

Important! Please make sure you read and retain this user manual for future reference. Failure to adhere to the directions for use within this manual may impact your Manufacturer's Warranty. Adherence to the directions for use in this manual is extremely important for health and safety. Failure to strictly adhere to the requirements in this manual may result in personal injury, property damage and affect your ability to make a claim under the manufacturer's warranty provided with your product. Products must be used, installed and operated in accordance with this manual. You may not be able to claim on the manufacturer's warranty in the event that your product fault is due to failure to adhere to this manual.



**A RESIDENTIA
GROUP INITIATIVE**



| Contents | Page |
|-------------------------------|------|
| Welcome | 2 |
| Important Safety Instructions | 4 |
| Your Dishwasher | 6 |
| Control Panel | 7 |
| Technical Information | 8 |
| Installation Instructions | 9 |
| Preparing Your Dishwasher | 12 |
| Operating Your Dishwasher | 20 |
| Maintenance and Cleaning | 23 |
| Troubleshooting | 28 |
| Error Codes | 30 |
| Warranty | 32 |

Important Safety Instructions

GENERAL SAFETY INSTRUCTIONS

WARNING! When using your dishwasher, always follow the precautions listed below. Failure to do so can cause injury or damages. You may then not be covered by warranty for this damage.

Only plug this appliance directly into an AC power supply which is properly earthed and had the correct voltage. Refer to the appliance rating plate (located on the rear of your clothes dryer) for the voltage information. In the event of a malfunction or breakdown, earthing will reduce the risk of an electric shock by providing a path of least resistance of electric current. This appliance is equipped with an earthing conductor plug.

Caution If this appliance is supplied from an extension cord, power-board or other power adapter, the extension cord/power-board must be positioned so that it is not subject to moisture or risk of moisture. For safety reasons, we strongly advise against the use of double adaptors, power-boards, extension leads or other similar devices.

This appliance is not intended for use by persons (including children) with reduced physical, sensory or mental capabilities, or lack of experience and knowledge, unless they have been given supervision or instruction concerning use of the appliance by a person responsible for their safety. Children should be supervised to ensure that they do not play with the appliance.

Important!

- If the electrical cord of this appliance is damaged, it must be replaced by the Manufacturer, Authorised Service Agent or similarly qualified person in order to avoid a hazard. Damage to the appliance, including the power cord, is not covered under the manufacturer's warranty and a fee for service may be payable.
- Installation and repair can only be carried out by a qualified technician or suitably licensed tradesperson.
- This appliance is intended to be used indoors only in a household environment or similar applications such as:
 - staff kitchen areas in shops, offices and other working environments;
 - farm houses;
 - by clients in hotels, motels and other residential type environments;
 - bed and breakfast type environments.
- It is not intended for use in Commercial environments.
- Children shall not play with the appliance. Cleaning and user maintenance shall not be done by children without supervision.
- Packaging material could be dangerous for children!
- To protect against the risk of electrical shock, do not immerse the unit, cord or plug in water or other liquid.
- Please unplug before cleaning and performing maintenance on the appliance. Use a soft cloth moistened with mild soap, and then use a dry cloth to wipe it again.
- Improper connection of the equipment-earthing conductor can result in the risk of an electric shock. Check with a qualified electrician or service representative if you are in doubt whether the appliance is properly grounded.
- Do not modify the plug provided with the appliance; If it does not fit the outlet. Have a proper outlet installed by a qualified electrician.
- Do not abuse, sit on, or stand on the door or dish rack of the dishwasher.
- Do not operate your dishwasher unless all enclosure panels are properly in place. Open the door very carefully if the dishwasher is operating, there is a risk of water squirting out.
- Do not place any heavy objects on or stand on the door when it is open. The appliance could tip forward.
- When loading items to be washed:
 - 1) Locate sharp items so that they are not likely to damage the door seal;
 - 2) Warning: Knives and other utensils with sharp points must be loaded in the basket with their points facing down or placed in a horizontal position.
- Some dishwasher detergents are strongly alkaline. They can be extremely dangerous if swallowed. Avoid contact with the skin and eyes and keep children away from the dishwasher when the door is open.
- Check that the detergent powder is empty after completion of the wash cycle. Do not wash plastic items unless they are marked "dishwasher safe" or the equivalent.
- For unmarked plastic items not so marked, check the manufacturer's recommendations.
- Use only detergent and rinse agents recommended for use in an automatic dishwasher.
- Never use soap, laundry detergent, or hand washing detergent in your dishwasher.
- The door should not be left open, since this could increase the risk of tripping. If the supply cord is damaged, it must be replaced by the manufacturer or its service agent or a similarly qualified person in order to avoid a hazard.



Important Safety Instructions (Cont.)

GENERAL SAFETY INSTRUCTIONS CONTINUED

- During installation, the power supply must not be excessively or dangerously bent or flattened.
- Do not tamper with controls.
- The appliance needs to be connected to the main water valve using new hose sets. Old sets should not be reused.
- To save energy, in standby mode, the appliance will switch off automatically while there is no any operation in 30 minutes.

UNPACKING

During transportation, protective packaging was used to protect the appliance against any damage. After unpacking, please dispose of all elements of packaging in a way that will not cause damage to the environment. All materials used for packaging the appliance are environmentally friendly; they are 100% recyclable and are marked with the appropriate symbol. Check with your local council on which packaging elements can be recycled kerbside and which may need to be disposed of at your local recycling drop off centre.

Tip! Soft plastics can be recycled at most major grocery retailers. Polystyrene (EPS) foam may not be accepted by your local council for recycling- check <http://epsa.org.au/> for details of your local EPS recycler.

Caution! During unpacking, the packaging materials (polythene bags, polystyrene pieces, etc.) should be kept out of reach of children.

BEFORE FIRST USE

Ensure all packaging, user manuals, paper and plastic are removed from within the clothes dryer before operation.

- Ensure the vents aren't blocked and adequate airflow exists with your chosen location.
- Always check your clothing articles care instructions to ensure they are suitable for use within a clothes dryer. Not all fabric types/clothing articles are suitable for use within vented clothes dryers.

DISPOSAL

Old appliances should not simply be disposed of with normal household waste but should be delivered to a collection and recycling centre for electric and electronic equipment. A symbol shown on the product, the instruction manual or the packaging shows that it is suitable for recycling.

- Materials used to manufacture the appliance are recyclable and are labelled with information concerning this. By recycling materials or other parts from used devices you are making a significant contribution to the protection of our environment.
- Information on appropriate disposal centres for used devices can be provided by your local council or authority.

Your Dishwasher

THE MAIN COMPONENTS

Note: The images may differ slightly to your model and are for general reference only.



Figure 1- Front view

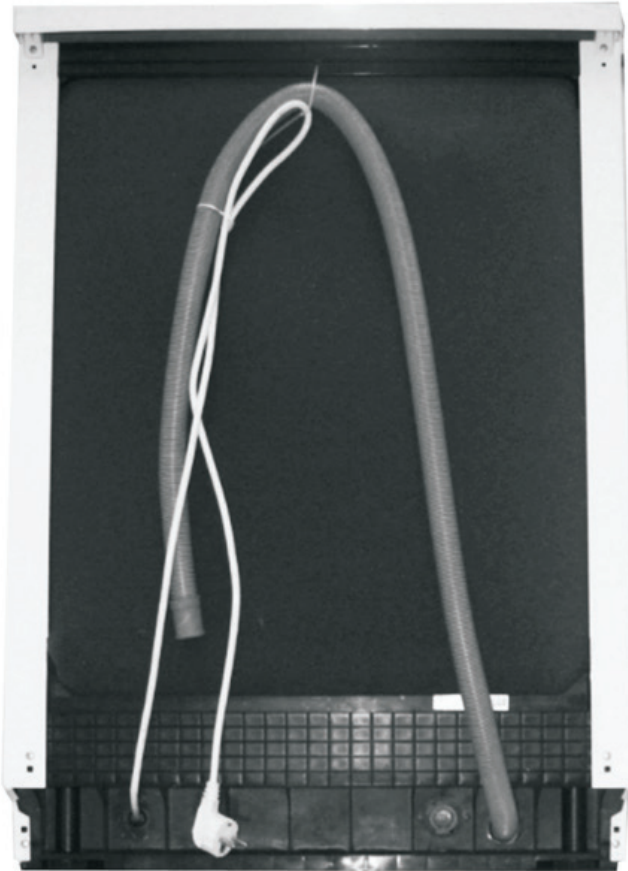

Figure 2- Back view



Control Panel

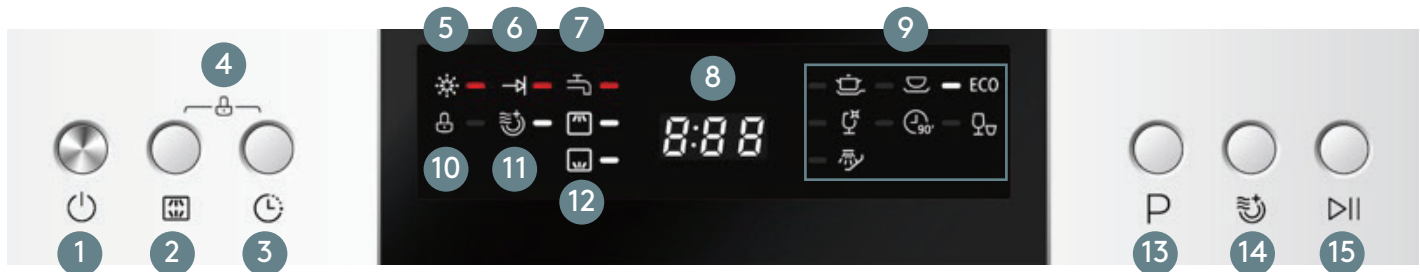
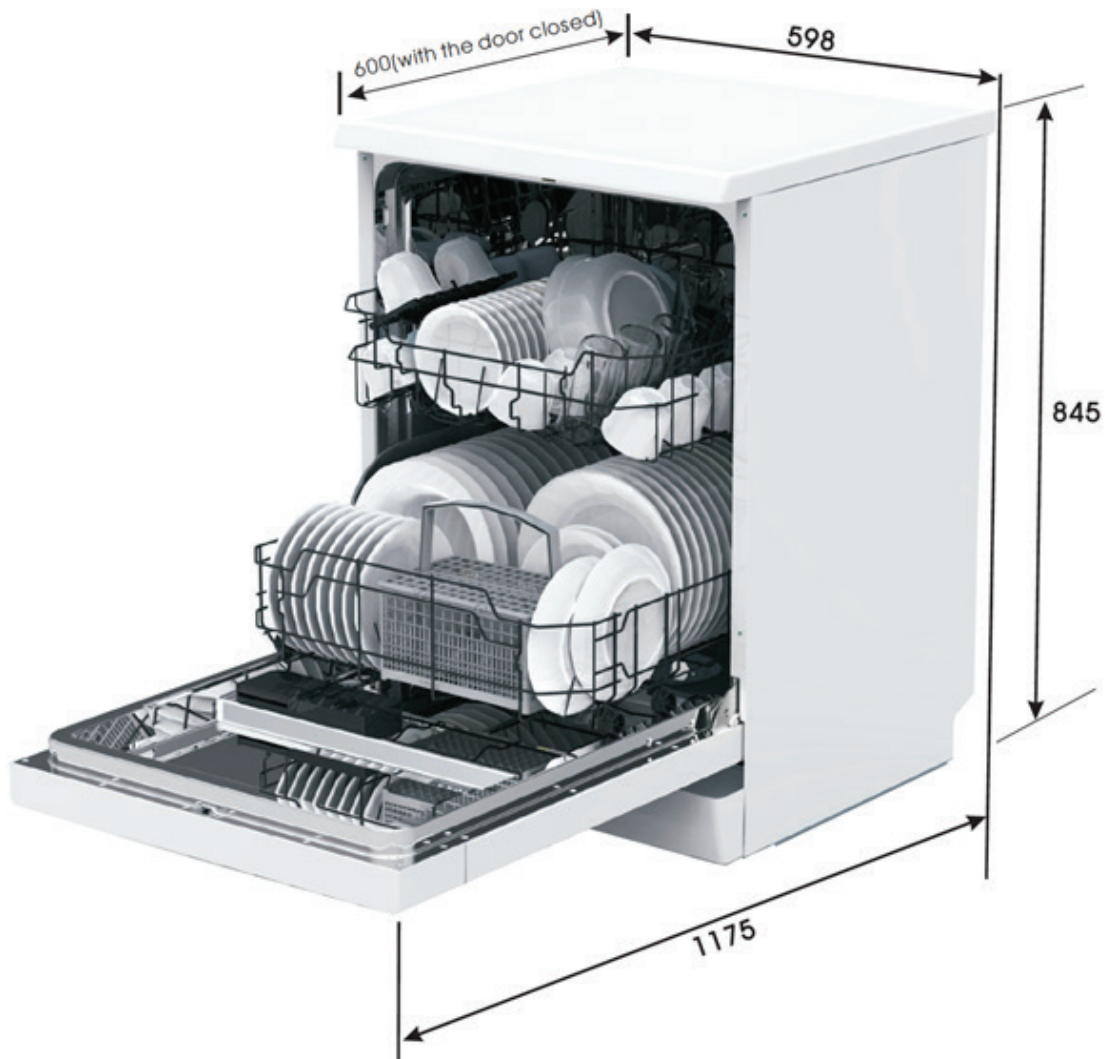

Figure 3- Control panel

1. On/Off button: Switches the dishwasher On and Off.
2. Wash Zone button: Press this button to switch on/off the upper wash zone and lower wash zones.
3. Delay button: Press the button to set a delayed start time.
4. Child lock function: Simultaneously press the Delay and Wash Zone buttons to activate child lock.
5. Rinse Aid indicator: Indicates when the rinse aid is low and that the dispenser needs to be refilled.
6. Program Ended indicator: Indicates when the dishwasher program has been completed.
7. Water tap indicator: LED indicates when the water supply tap is closed and needs to be turned on.
8. LED Display: Displays the remaining time, delay time and any error codes.
9. Program indicators: LED will alight next to the selected wash program.
10. Child lock indicator: LED indicates whether the child lock function is activated or not.
11. Extra Drying indicator: LED indicates whether the Extra Drying function is activated or not.
12. Lower Basket Rack Zone indicator: indicates the lower zone is activated (from using the Wash Zone button).
Upper Basket Rack Zone indicator: indicates the upper zone is activated (from using the Wash Zone button).
13. Program button: Press this button to cycle through the program options (i.e. Intensive, Glass, Eco, etc)
14. Extra Drying button: Press this button to activate the Extra Drying function. This function will heat the water to a hotter temperature during its final rinse cycle, creating extra heat. It can only be used with the Intensive, Heavy, ECO, Glass and 90min programs.
15. Start/Pause button: Press this button to start the selected washing program or pause the washing program when running.

Technical Information



| | |
|--------------------|---|
| Height: | 845mm |
| Width: | 598mm |
| Depth: | 600mm (with door closed), 1175mm (with door open) |
| Water Pressure: | 0.04-1.0MPa=0.4-10 bar |
| Power Supply: | AC 220-240V/50Hz |
| Power Consumption: | 1760-2100W |
| Capacity: | 14 Place Settings |



Installation Instructions

WARNING! Electrical shock hazard

Disconnect electrical power before installing the dishwasher. Failure to do so could result in death or electrical shock.

Important! The installation of the dishwasher, plumbing and electrical outlets should be completed by licenced tradespeople.

POWER CONNECTION

WARNING! For personal safety:

- Do not use an extension cord, powerboard or a power adapter with the dishwasher. It should be connected directly into a power socket.
- Do not under any circumstances, cut or remove the earthing connection from the power cord.

ELECTRICAL REQUIREMENTS

Please refer to the rating label on the dishwasher, to find out the rated voltage and ensure that the dishwasher is connected to the appropriate power supply. Use the required 10 Amp fuse and it should be connected to its own dedicated circuit serving only this appliance.

ELECTRICAL CONNECTION

Ensure the voltage and frequency of the power corresponds to that noted on the dishwasher's appliance rating plate. Only insert the plug into an electrical socket which is earthed properly. If the electrical socket to which the appliance must be connected is not appropriate for the plug, have a licenced electrician replace the socket- do not use a power adapter as this can lead to overheating.

POSITIONING THE DISHWASHER

Important! Ensure that the dishwasher is properly earthed before use.

Position the appliance in the desired location. The back should rest against the wall behind it, and the sides, along the adjacent cabinets or walls. The dishwasher is equipped with both a water supply hose and drain hose that can be positioned either to the right or the left sides to facilitate proper installation.

Ensure that your selected location has an accessible power-point (power outlet) which the dishwasher's power cord can reach without strain. If there isn't a suitable power point (power outlet) located nearby, please engage a licenced electrician to install a new power socket. Do not use extension leads, power boards or adapters.

LEVELLING THE DISHWASHER

Once the dishwasher is positioned in your desired location, the height and level of the dishwasher can be altered by adjustment of the screwing legs/feet. In any situation, the appliance must not be inclined more than 20°, as this will affect its operation and performance.

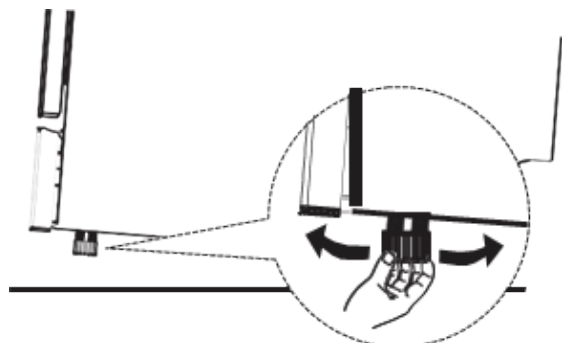

Figure 4. Screwing the dishwasher legs/feet clockwise or anti-clockwise to adjust its level.

Installation Instructions (Continued)

WATER SUPPLY AND DRAIN CONNECTION

Cold Water Connection

Important! Your dishwasher should only be connected to the cold water outlet. It has an in-built heating element to heat up the water to the required temperatures depending on the selected wash program.

Connect the cold water supply hose to a threaded $\frac{3}{4}$ inch tap connector and make sure that it is fastened tightly in place.

Important! If the water pipes are new or have not been used for an extended period of time, let water pass through them into a bucket until the water runs clear. This precaution is required to avoid the risk of the water inlet becoming blocked or dirty water damaging your new dishwasher.



Figure 5- Connecting the supply hose to a $\frac{3}{4}$ inch tap.

Note. If your dishwasher is not going to be used for an extended period of time, please turn the water supply to your dishwasher off at its supply tap and switch off its power supply at its power outlet (or unplug the appliance).

Connection of drain hose

The ideal connection of the dishwasher waste pipe is straight on to your sinks' PVC waste trap pipe with a dishwasher spigot- an example of which is shown below in Figure 6. Also refer to location A in Figure 7, showing this connection method.



Figure 6- Typical waste trap from a sink with the dishwasher spigot.

Installation Instructions (Continued)

WATER SUPPLY AND DRAIN CONNECTION CONTINUED

Important! New waste traps typically have the dishwasher spigot sealed off with plastic and requires the plumber or licensed installer to drill out the center of the spigot to allow water to flow. It's important to ensure this spigot is drilled out before calling our Service team to respond to a dishwasher failure, as there will be a fee payable should we attend and find this non-warranty installation fault.

If you do not have a waste trap with the dishwasher spigot, you can also insert the drain hose directly into a drain pipe, providing it's diameter is a minimum of 4cm. Refer to location B shown in Figure 7.

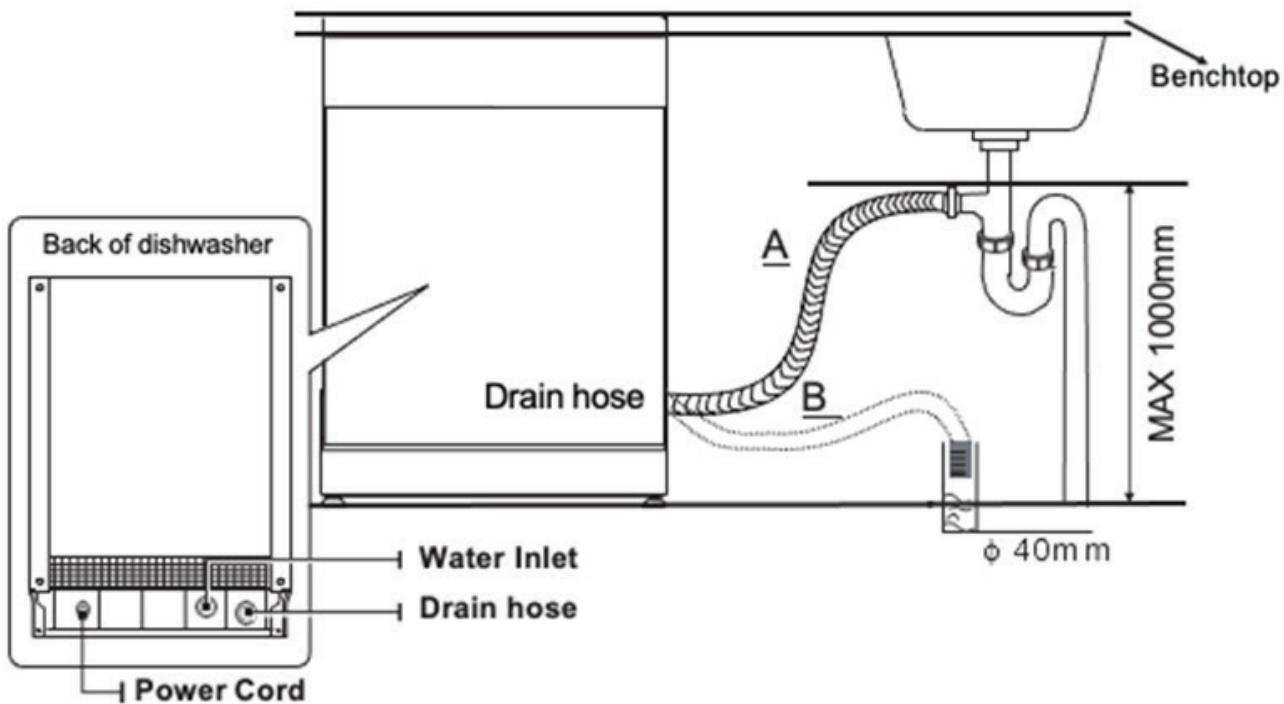

Figure 7- Shows the correct positioning of the drain hose.

Important! The height of the drain hose must be less than 1000mm at all times, including at its final connection. If the drain hose is higher at any point, the dishwasher will not be able to drain effectively and will cause a fault during its operation.

Note. It's critical for the effective operation of your dishwasher, that the waste pipe is not over-bent or kinked as this will restrict flow and can cause a fault with the dishwasher. When pushing the dishwasher back into it's housing, take special care to ensure that the waste pipe is not kinked or the dishwasher sitting on the waste pipe.

Note. The end of the drain hose must not be immersed in water to avoid back flow into the dishwasher.

You can also let the drain hose run directly into the sink, ensuring that the waste pipe is not bent or kinked, only when the sink is lower than the 1000mm maximum height.

Drain hose extensions

If you need to use a drain hose extension, please ensure that your installer uses a similar drain hose. The total length of drain hose must be no longer than 4 meters, otherwise the cleaning performance of the dishwasher will be impacted. This will also effect the manufacturer's warranty as a non-compliant installation.

Syphon connection

The waste connection must be at a height less than 1000mm from the bottom of the dishwasher. The water drain hose connection must be fixed in place.

Preparing Your Dishwasher

RINSE AID

Rinse aid is released during the dishwasher’s final rinse to prevent water from forming droplets on your dishes, which can leave spots and streaks. It also improves drying by allowing water to roll off the dishes. Your dishwasher has been designed to use liquid rinse aids.

WARNING! Only use branded rinse aid suitable for use in dishwashers. Never fill the rinse aid dispenser with any other substances (i.e. Dishwasher cleaning agent, liquid detergent). This would damage the appliance and void the Manufacturer’s Warranty.

If the rinse-aid indicator light is illuminated () on the control panel, then you will need to refill the dispenser, following the instructions below. You can always estimate the amount of rinse-aid within the reservoir from the colour of the optical level indicator located next to the cap. When the rinse-aid reservoir is full, the indicator will be fully dark. The size of the dark dot decreases as the rinse-aid diminishes. You should never let the rinse aid level be less than 1/4 full.

Optical Level Indicator



- Full
- ◐ 3/4 full
- ◑ 1/2 full
- ◒ 1/4 full
- Empty

Figure 8- Rinse-aid optical level indicator for reservoir.

Tip! A common complaint for all dishwashers is that dishes are coming out wet after completing its program. Rinse aid will greatly improve drying results, but there are a number of factors which can effect drying performance, including the crockery items you are washing. Refer to the Dishwasher Drying Tips for some more guidelines around this topic.

FILLING THE RINSE-AID DISPENSER

Step 1 Remove the Rinse-aid dispenser cap by screwing it in an anti-clockwise direction. Refer to Figure 9.

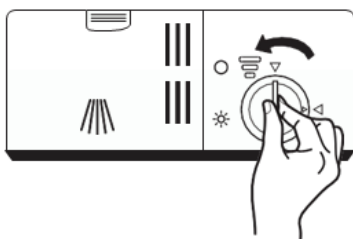

Figure 9- Removing the Rinse-aid dispenser cap.



Figure 10- Filling the Rinse-aid reservoir.

Step 2 Carefully pour the dishwasher rinse-aid into the reservoir, whilst being careful to avoid it overflowing. Refer to Figure 10.

Tip! Wipe up any overflow or spilt rinse-aid as this can lead to excessive foaming in the next dishwasher cycle.



Preparing Your Dishwasher (Continued)

FILLING THE RINSE AID DISPENSER CONTINUED

Step 3 Re-insert the Rinse-aid cap and screw in a clockwise direction to lock it in place. Refer to Figure 11.



Figure 11- Re-fitting the cap onto the Rinse-aid dispenser.

ADJUSTING THE RINSE-AID DISPENSER

You can increase or decrease the amount of Rinse-aid being dispensed by your dishwasher for each cycle, using the adjustment dial.

Turn the Rinse-aid dispenser dial to a number between 1 and 6, where the higher number dispenses more rinse-aid. If you are finding your dishes are not drying properly or are spotted after the program has finished, adjust the dial to the next higher number until you find that your dishes are spot-free. Reduce the setting if there are sticky whitish coloured stains on your dishes or a bluish film on your glassware or knife blades.

Note. The factory default setting is 4, for the rinse-aid.

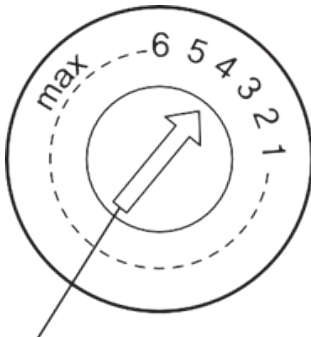

Adjustment dial

Figure 12- Rinse aid dispenser dial.

DISHWASHER DETERGENT

The chemical ingredients that compose the dishwasher detergent are necessary to remove, break-down and dispense all dirt out of the dishwasher. Most of the commercial quality detergents are suitable for this purpose.

Tip! If you are finding that you are unhappy with the washing performance of your dishwasher, try using alternative wash programs (i.e. a more intensive program) and also try using alternative dishwasher detergents. We do find that some brands outperform others in terms of washing results.

WARNING! Proper use of dishwashing detergent.

- Use only detergent specifically made for dishwashers. Keep your detergent dry and fresh.
- Don't put powdered detergent into the dispenser until you are ready to start a new wash cycle.

WARNING! Dishwasher detergent is corrosive and highly dangerous! Always keep dishwasher detergent out of reach of children and follow the instructions provided by the dishwasher detergent brand for handling and storage.

Preparing Your Dishwasher (Continued)

FILLING THE DISHWASHER DETERGENT DISPENSER

Step 1 Press the release catch on the detergent dispenser, to open the cover. Refer to Figure 13.



Figure 13- Release catch to open the detergent dispenser cover.

Step 2 Add the detergent (powder or tablet) into the larger cavity (labelled A in figure 14 below) which is used for the main wash cycle. For more heavily soiled wash loads, you can also add some detergent into the smaller cavity (labelled B in figure 14 below) which is used for the pre-wash cycle.

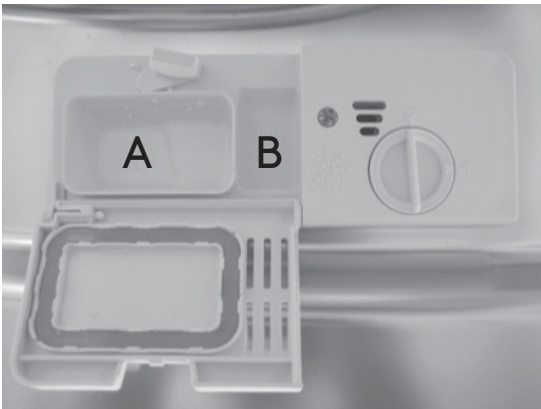

Figure 14- The open dishwasher detergent dispenser.

Step 3 Close the dispenser cover and press on it until it locks in to place (you'll hear a click).



Figure 15- Closing the dispenser cover.

Note. Please refer to the Manufacturer's instructions on the dishwasher detergent you are using. Dosage instructions will vary.



Preparing Your Dishwasher (Continued)

USING THE BASKETS

Your dishwasher is supplied with an upper and lower basket, along with a removable plastic cutlery basket which is designed to sit in the lower basket.

Adjusting the upper basket height

The height positioning of your upper basket can easily be adjusted between two settings, allowing you to accommodate taller dishes in either the upper or lower basket. Your Esatto dishwasher model (IDW7CS) is fitted with quick adjust handles on either side of the upper basket.

To adjust the height of the upper basket, follow these steps.

Step 1 Slide out the upper basket to the end of its extension arms.

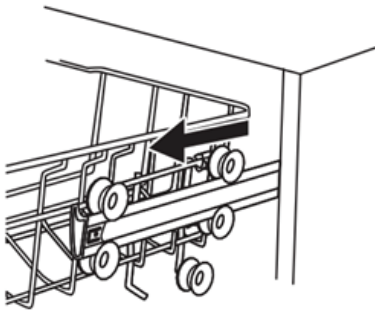

Figure 16- Slide out the upper basket.

Step 2 Lift the basket rack upwards until it locks into the upper position. If the basket is already locked in its upper position and you wish to lower the basket rack, go to step 3.



Figure 17- Lifting the upper basket into its upper position by holding and lifting the two sides of the basket rack.

Preparing Your Dishwasher (Continued)

USING THE BASKETS CONTINUED

Step 3 To lower the upper basket, simply pull the quick release levers on either side to lower the basket rack.



Figure 18- Using the quick release levers on both sides of the upper basket rack to move it to the lower position.

FOLDING BACK THE GLASS RACKS

To make room for taller items in the upper basket, you can raise the glass rack upwards, allowing you to lean the tall glasses against it (i.e. holding wine glass stems). You can also remove it when it is not required for use.

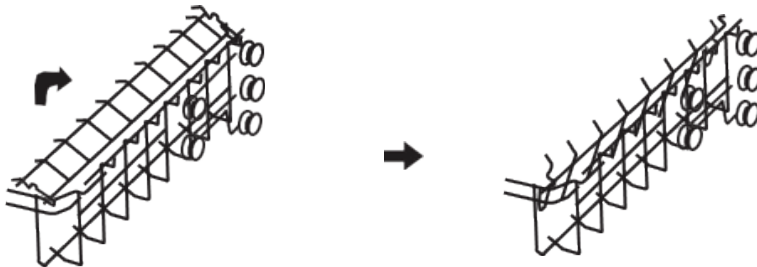

Figure 19- Adjusting the upper basket glass racks.

FOLDING BACK THE RACK ARMS

The rack arms (or spikes) of the lower basket are used for holding and organising plates and bowls. These can be lowered to make room for large items as required. Simply click them downwards using light force, or click them into the upright position- refer to figure 20 below.

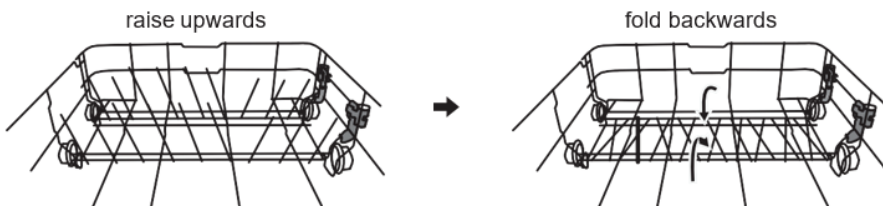

Figure 20- Raising and lower the rack arms within the lower basket.



Preparing Your Dishwasher (Continued)

PREPARING AND LOADING DISHES INTO YOUR BASKET RACKS

Caution! Some items are not safe for use in dishwashers and can be damaged or become discoloured when washed within a dishwasher. Always check the care information on your utensils and crockery to ensure they are dishwasher safe.

Note Some items may require washing on a lower temperature program to prevent damage.

Tip! To prevent damage to glass and cutlery, avoid removing it immediately after the program has ended as they will be at their hottest temperature at this time.

The following items are not suitable for washing within your dishwasher:

- Cutlery with wooden, horn china or mother of pearl handles
- Plastic items that are not heat resistant
- Older cutlery with glued parts that are not temperature resistant
- Bonded dishes
- Pewter or copper items
- Crystal glassware
- Steel items subject to rusting
- Wooden platters
- Items made from synthetic fibres

The following items have limited suitability for washing in your dishwasher:

- Some types of glassware can become dull after a large number of washes
- Silver and aluminium parts have a tendency to discolour during washing
- Glazed patterns on ceramics may fade if washed frequently

RECOMMENDATIONS FOR LOADING

Before loading your dishes into the dishwasher, please consider:

- Scraping off any large amounts of residual food on your plates and bowls.
- Soften any remnants of burnt food in pots or pans.

Note. The features and appearance of your basket racks and cutlery basket may vary slightly by model.

For optimal performance of the dishwasher, follow these loading guidelines:

- Items such as cups, glasses, pots, pans, etc. are faced downwards, so as not to collect water.
- Curved items, or ones with recesses, should be loaded so that water can run off, rather than sit in any crevasse.
- All utensils are stacked securely and can not tip over.
- All utensils are placed in the way that the spray arms can rotate freely during washing.
- Load hollow items such as cups, glasses, pans etc. With the opening facing downwards so that water cannot collect in the container or a deep base.
- Dishes and items of cutlery must not lie inside one another, or cover each other. To avoid damage, glasses should not touch one another.
- The upper basket is designed to hold more delicate and lighter dishware such as glasses, coffee and tea cups.
- Long bladed knives stored in an upright position are a potential hazard! Long and sharp items of cutlery such as carving knives must be positioned horizontally in the upper basket.
- Please do not overload your dishwasher. This is important for good results and for reasonable consumption of energy.

Tip! Avoid washing very small items within your dishwasher as they could easily fall out of the basket and interfere with a spray arm for the filter.

Caution! When loading the basket racks, be careful in particular when loading sharp items or large pots to ensure no damage is caused to the protective coating on the racks. If this protective coating is scratched or cut, it can lead to potential rusting over time. This type of damage is not covered under the Manufacturer's warranty.

Preparing Your Dishwasher (Continued)

Loading the upper basket rack

The upper basket rack is designed to hold more delicate and lighter dishware such as glass, coffee/tea cups, saucers, small plates and small bowls. Position the dishes so that they will not get moved by the spray of the water.



Figure 21- Example loading of the upper basket rack.

Loading the lower basket rack

The lower basket rack is designed to hold the larger items and those most difficult to clean. Items such as pots, pans, lids, serving dishes, dinner plates, bowls, etc, as shown in figure 22 below.

It is preferable to place serving dishes and lids on the side of the racks in order to avoid blocking the rotation of the upper spray arm.

The maximum diameter advised for plates in front of the detergent dispenser is 19cm, to avoid interfering with the opening of the detergent dispenser.

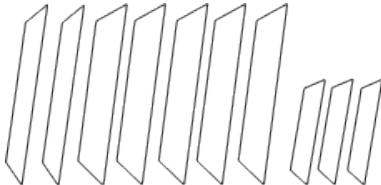

Figure 22- Example loading of the lower basket rack.



Preparing Your Dishwasher (Continued)

Loading the cutlery tray

Your dishwasher is fitted with an upper cutlery tray which can be lifted out of your dishwasher for convenience of unloading. This retracting cutlery tray allows for optimal loading and cleaning of your cutlery whilst maximising space in the lower basket rack (where traditionally a cutlery basket would be located).

Cutlery should be placed into the plastic cutlery tray separately from each other to ensure that the utensils do not nest together. When the cutlery (in particular spoons) is stacked in close proximity and nesting together, the washing performance will be impacted.

WARNING! Do not let any utensils protrude down through the bottom of the cutlery basket as this can interfere with the spray arm. Always load sharp utensils with the sharp point downwards, to avoid risk of injury.

Tip! Long utensils can be washed by sitting them in the centre of the tray, as pictured in Figure 23 below.

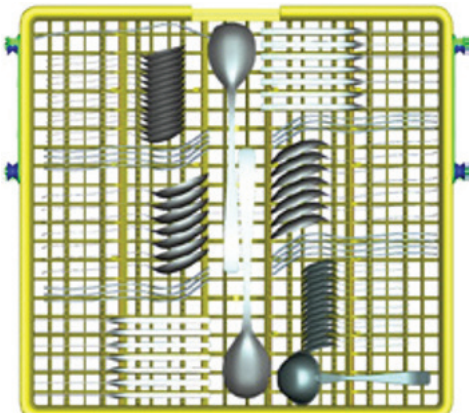

Figure 23- Optimum loading of your cutlery tray.

Removing the dishes at the end of a cycle

To prevent water dripping from the upper basket onto your dishes in the lower basket rack, we recommend that you slide out and empty the lower basket rack first, followed by the upper basket rack.

Caution! Items will be hot immediately after the wash program is complete! To prevent damage, do not take glass and cutlery out of the dishwasher for around 15 minutes after the program has ended.

Tip! To maximise the drying performance of your dishwasher, once the wash program has completed and the audible tone has sounded, simply open your dishwasher door slightly to allow for some of the steam to escape. Leave your dishwasher for at least 15-30 minutes and you'll find the drying results will improve greatly.

Operating Your Dishwasher

TURNING YOUR DISHWASHER ON AND STARTING A WASH CYCLE

Step 1 Load your dishwasher according to the guidelines in the Preparing Your Dishwasher section of this manual.

Step 2 Load the dishwasher detergent dispenser (refer to section Preparing Your Dishwasher in this manual).

Step 3 Close the dishwasher door and press the Power button to turn on your dishwasher, located on the control panel.

Step 4 Press the Program button (located on the control panel) to cycle through the various dishwasher programs, to select your desired wash program. It will cycle through the options in the following order: ECO > Glass > 90 Min > Rapid > Pre-wash > Intensive > Heavy > ECO etc. The LED will alight alongside the corresponding program selected.

Step 5 (optional) Add any additional options to the wash program, including Half Load or Extra Drying.

- To activate the Half Load function, press the Half Load button.
- To activate the Extra Drying function, press the Option button.

Note. Extra Drying cannot be added to the Rapid or Soak programs.

Step 6 (optional) Add any Delay start, if you would like to postpone the wash cycles start by 3, 6 or 9 hours. Simply press the Delay button to cycle through the options.

Step 7 Press the Start/Pause button to start the wash program, using the settings you've selected.

Tip! Whilst your dishwasher is operating a wash cycle, you can pause the program at any time by pressing the Start/Pause button. To un-pause, simply press the Start/Pause button once again and it will resume its' wash program. When the dishwasher is in its paused status, the colon symbol between the Hours and Minutes remaining (i.e. H:MM) will stop blinking and be displayed solid.



Operating Your Dishwasher (Continued)

YOUR DISHWASHERS' WASH PROGRAMS

Your dishwasher has the following wash programs. Please refer to the table below to determine which program is most suitable for each load.

| Program | Use | Process of the cycle | Suggested detergent for both pre-wash and main compartment | Running time (mins) | Energy Use (kWh) | Water use (L) | Rinse Aid |
|---------------|--|---|--|---------------------|------------------|---------------|-----------|
| Intensive | For heavily soiled crockery and normally soiled pots/pans and dishes with dried on soiling. | Prewash 50° Wash 60° Rinse Rinse 65° Drying | 5g/27.5g (or all-in-1 tablet) | 170 | 1.6 | 18.5 | Yes |
| Heavy | For heavily soiled loads such as plates, glasses and lightly soiled pots and pans. | Prewash 45° Wash 55° Rinse Rinse 65° Drying | 5g/27.5g (or all-in-1 tablet) | 160 | 1.3 | 13.5 | Yes |
| ECO | This is the standard program and is suitable to clean normally soiled crockery and cutlery. It is the most efficient program for energy and water consumption for a normal load. | Prewash Wash 45° Rinse 50° Drying | 5g/27.5g (or all-in-1 tablet) | 175 | 0.78 | 12.3 | Yes |
| Glass | Ideal for lightly soiled crockery and glassware | Prewash Wash 42° Rinse Rinse 60° Drying | 0/25g (or all-in-1 tablet) | 125 | 0.8 | 13 | Yes |
| 90 mins | Ideal for daily normally soiled loads that need a quick wash, glassware, etc. | Wash 65° Rinse Rinse 65° Drying | 0g/25g (or all-in-1 tablet) | 90 | 1.2 | 11.5 | Yes |
| Rapid | A shorter wash for lightly soiled loads that do not need drying | Wash 40° Rinse Rinse 45° | 0g/25g (or all-in-1 tablet) | 30 | 0.6 | 11.5 | Yes |
| Pre-wash | To rinse dishes that you plan to wash later that day | Pre-wash | - | 8 | 0.02 | 4 | No |

Note. The ECO program was used for the test cycle to obtain this dishwasher's MEPS and WELS rating in accordance with AS/NZS 2007.1, as follows:

- Capacity: 14 place settings
- Position of upper basket: upper wheels on rails
- Rinse aid setting: 6
- Open the door slightly (~50mm) to assist with the drying of dishes after the completion of each wash.

Operating Your Dishwasher (Continued)

CHANGING THE PROGRAM

Once the dishwasher has started a wash cycle program, you can change the selected program within the first minute or so, otherwise the detergent may have been already released. When you start a new program, the dishwasher will drain any residual water, hence you will need to re-fill the detergent dispenser in the event that it's already dispensed it.

To change the program within the first minute, press the Start/Pause button and the dishwasher will enter it's standby state. Press and hold the Program button for 3 seconds. You can now press the program button to cycle through the programs and select an alternative wash program. Once you've selected the new program, press the Play/Pause button once more to start.

The colon symbol between the Hours and Minutes remaining (i.e. H:MM) will flash intermittently once running again.

Note. If you open the door during a wash cycle, the dishwasher will automatically pause. The colon symbol between the Hours and Minutes remaining (i.e. H:MM) will stop flashing to indicate that the dishwasher is in standby mode. An audible tone will sound every 1 minute until you close the door. After you close the dishwasher door, it will automatically resume its wash program after 10 seconds.

Caution! It is dangerous to open the dishwasher door during operation. The hot water or steam inside can easily scald you.

FORGOT TO ADD A DISH

A forgotten dish can be added any time before the detergent dispenser has been released.

Step 1 Press the Start/Pause button to put the dishwasher into standby mode.

Step 2 Open the door a little, allowing for the spray arms to stop spinning, before opening the door fully.

Step 3 Add any forgotten dishes or cutlery.

Step 4 Close the door.

Step 5 Press the Start/Pause button for the machine to resume its program after 10 seconds.

AT THE COMPLETION OF A WASH CYCLE

When your dishwasher has completed its wash program cycle, an audible tone will sound for 8 seconds, before stopping. Follow these steps for optimal drying performance.

Tip! The colon symbol between the Hours and Minutes remaining (i.e. H:MM) will be solid (i.e. not flashing/blinking) to indicate the program has ended. The LED next to the Program Ended Indicator will also be illuminated.

Step 1 Switch off your dishwasher using the Power button. Turn the water supply off at its tap.

Step 2 Open the door slightly (around 50mm) to allow for the steam to escape. Leave the dishwasher for 15 minutes where possible, to allow for your dishes to cool a little. This will also assist the drying process.

Step 3 Unload the dishwasher, starting with the lower basket rack first, before unloading the upper basket rack. This will help to avoid water dripping from the upper basket rack onto your lower dishes.

Note. It is normal for the dishwasher and it's racks to be wet inside. Plasticware will not dry as well as ceramic crockery, porcelain or metal cutlery, as plastic by nature won't get as hot nor retain heat in the same way. Due to this, plastic very rarely dries within a dishwasher.

Caution! Be careful when opening the dishwasher door. The hot water or steam inside can easily scald you.



Maintenance and Cleaning

Some simple maintenance and cleaning steps must be followed to ensure that your dishwasher continues to operate at its optimum and without issue. Failure to follow these basic maintenance and cleaning steps may void your Manufacturer's warranty or result in a service fee in the event of a technician attending site under warranty.

EXTERNAL CARE

Doors and seals

Using a soft, lightly damp cloth, wipe down the door seals to remove any residual food deposits. We recommend this process at least monthly, or when an accidental spill occurs dirtying the door seal area.

When the dishwasher is being loaded, it's common for food and drink residues to drip onto the sides of the dishwasher door and the rubber seals themselves. These surfaces are outside the wash cabinet and are not accessed by water from the spray arms. Any deposits should be wiped off before the door is closed.

The control panel

Using a soft, lightly damp cloth, wipe down the control panel when cleaning is required. After cleaning, ensure that you dry the control panel thoroughly.

WARNING! To avoid penetration of water into the door lock and other electrical components, do not use a spray cleaner or pressure cleaner, of any kind. Never use abrasive cleaners or scouring pads on the outer surfaces as these may scratch the finish.

INTERNAL CARE

Base of the dishwasher

Residual food can build up at the base of the dishwasher, in particular near where the door meets the base. Using a soft, damp cloth, wipe any residual food residue away and around the rubber seals. This should be undertaken at least monthly or more if required.

Filter system

Having a clean filter system is critical to the ongoing cleaning performance of your dishwasher and this basic cleaning process is often neglected. The filter system is located in the base of the wash cabinet and it retains coarse debris from the washing cycle. This collected debris does cause the filters to clog over time and it's important to regularly check your filters and clean them as required. We recommend this to be done weekly when regularly using your dishwasher.

Follow the steps below to clean your filter system.

Note. Pictures are for reference only and your filter design may vary slightly depending on your model.

Step 1 Hold the coarse filter (round plastic head protruding from the metal mesh filter) and rotate it anti-clockwise to unlock the filter. Lift the filter upwards and out of the dishwasher, including the metal mesh main filter.

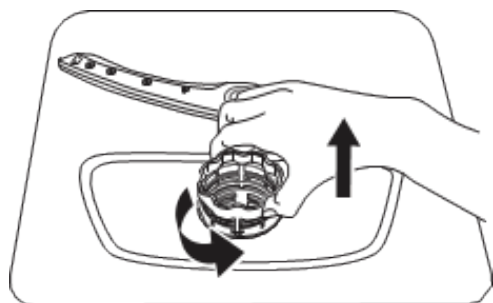

Figure 24- Unlocking the filter system from its' base housing.

Maintenance and Cleaning (Continued)

INTERNAL CARE CONTINUED

Step 2 With the filter assembly removed from the dishwasher, the fine filter can be pulled off the bottom of the filter assembly (refer to figure 25 below). This fine filter is covered by a fine mesh. Rinse this under running water from your tap and wipe any residual food residue off the filter.

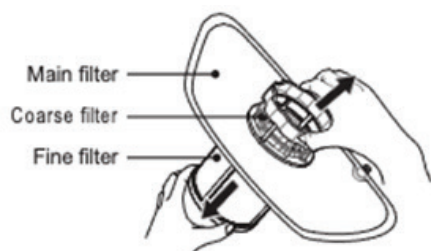

Figure 25- The filter assembly once removed from the dishwasher cabinet base.

Step 3 Detach the coarse filter by gently squeezing the tabs at the top and pulling it away from the mesh main filter. Under running tap water, clean both the mesh main filter and the coarse filter, removing any residual food or foreign objects. For a more thorough clean you may like to use a soft cleaning brush (i.e. a soft bristled toothbrush).



Figure 26- Rinsing and scrubbing any residual food particles or foreign objects from the filter components.

Step 4 Before re-fitting the filter housing into your dishwasher, it's worth checking that the housing in the base of the dishwasher is clean and clear of foreign objects (including bone fragments, broken glass, etc).

Caution! We recommend wearing gloves to protect your hands from any potential broken glass or sharp foreign objects that may be sitting in the base of the filter housing.

Step 5 Reassemble the filter in the reverse order of disassembly. Replace the filter into the base of the dishwasher and turn the coarse filter head in a clockwise direction until it locks back into place. You will notice the arrows to align on the coarse filter and the metal main filter when locked in position.

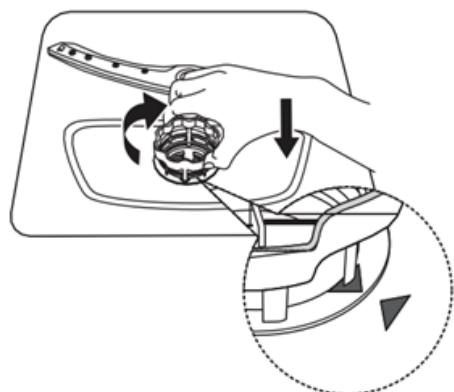

Figure 27- Refitting the filter system into the base of the dishwasher.



Maintenance and Cleaning (Continued)

WARNING! Do not over tighten the filters. Put the filters back in the correct sequence and securely lock in place, otherwise coarse debris could get into the system and cause a blockage or damage internally.

WARNING! Never use the dishwasher without the filters in place. Improper replacement of the filter will reduced the performance level of the dishwasher and may damage your dishes and utensils.

Note. Failure to regularly clean the filter will increase the risk of debris entering the internal system and causing damage to your appliance. Failure to follow the regularly maintenance steps outlined may lead to voiding your Manufacturer's warranty.

Cleaning the spray arms

It is necessary to clean the spray arms regularly, as hard water chemicals will clog the spray arm jets and bearings.

To clean the spray arms, follow the steps below.

Step 1 To remove the upper spray arm, hold the nut and rotate the arm clockwise to remove it.

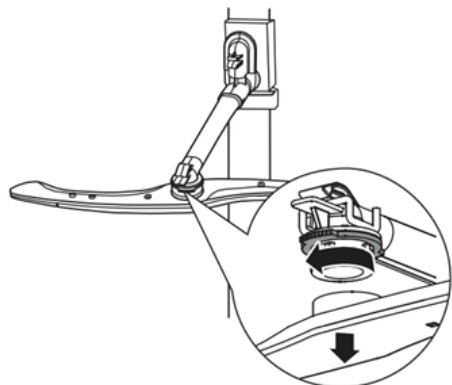

Figure 28- Removing the upper spray arm.

Step 2 To remove the lower spray arm, simply lift it in an upwards direction.

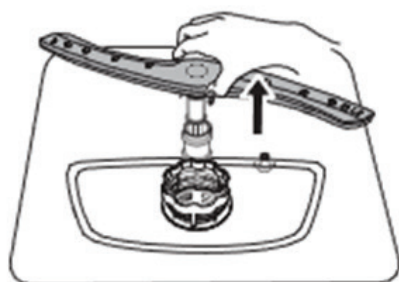

Figure 29- Removing the lower spray arm.

Step 3 Wash both spray arms in soapy warm water and use a soft brush (i.e. a tooth brush) to clean the jets. Rinse well and replace them in your dishwasher.

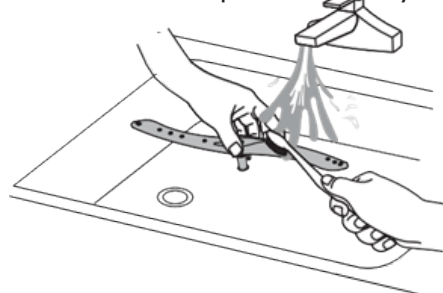

Figure 30- Cleaning the spray arms.

Maintenance and Cleaning (Continued)

INTERNAL CARE CONTINUED

Cleaning the interior cabinet

Over time, grime can accumulate on the interior walls of the appliance. A quick wipe down will do wonders for removing any dishwasher odour which can develop over time.

Step 1 Remove both the upper and lower basket racks and run them under hot water within the kitchen sink.

Step 2 Scrub the inside of the dishwasher with a rag or sponge dampened with hot water. If there is stuck on food residue, use some white vinegar to help remove it. Wipe down the rubber door gaskets (attached to the dishwasher cabinet) as these can collect food residue, mould and mildew.

Removing dishwasher odour

If your dishwasher has developed an odour and you've completed all of the internal cleaning steps listed above, you may like to try a cleaning cycle using some white vinegar and baking soda. Follow the steps below.

Step 1 Empty the appliance of all dishes.

Step 2 Place one cup of white vinegar in a stable bowl in the upper basket rack of your dishwasher.

Step 3 Set your dishwasher to the Intensive program and run for a full cycle. This is the hottest program for your dishwasher and the acids within the vinegar will help to break down any deposits on the interior of your dishwasher.

Step 4 Remove the bowl from the dishwasher once your cycle is complete. Sprinkle a cup of baking soda on the floor of the dishwasher.

Step 5 Set your dishwasher to the 90 Min program and run another empty cycle. This will dissolve all the baking soda and eliminate any remaining odour within your dishwasher.

FROST PROTECTION

Please take frost protection measures with your dishwasher in winter, particularly when you reside in cold regions.

After each washing cycle, follow these steps:

- Turn off the power to your dishwasher at the power point.
- Turn off the water supply to your dishwasher, at the supply tap and disconnect the water inlet pipe from the water valve on the rear of your dishwasher.
- Drain the water from the inlet pipe and water valve. Use a bucket to capture the water.
- Reconnect the water inlet pipe to the water valve at the rear of your dishwasher.
- Remove the filter assembly from the bottom of your dishwasher and use a sponge to soak up any residual water sitting in the filter housing.

Caution! Failure to follow these steps in regions prone to freezing can result in damage to your dishwasher. The manufacturer's warranty will not apply if these steps haven't been followed.



Maintenance and Cleaning (Continued)

GENERAL CARE ADVICE

After every wash

After every wash cycle, turn off the water supply to the dishwasher and leave the door slightly ajar so that moisture and odours are not trapped inside.

Remove the plug

Before undertaking any cleaning or maintenance steps, always remove the dishwasher's plug from its power outlet (power socket).

WARNING! Risk of electrocution if this step is not followed.

No solvents or abrasive cleaning

To clean the exterior and rubber parts of the dishwasher, never use solvents or abrasive cleaning products. Only use a cloth with warm soapy water. To remove stubborn stains or spots from the surface of the interior, use a cloth dampened with water and some white vinegar, or use a specially designed dishwasher cleaner available from your local supermarket.

When your dishwasher will not be used from sometime

It is recommended that you run a wash cycle with the dishwasher empty and then remove the plug from its power outlet (power socket), turn off the water supply at its supply tap and leave the door of the dishwasher slightly open. This will help the door seals to last longer, prevent odours from forming inside the appliance and prevent mould and mildew from developing.

Moving the appliance

In the event that the appliance must be moved, please try to keep it in its vertical position. If absolutely necessary, it can be positioned on its back. Failure to follow this step can lead to internal damage.

Door seals

One of the factors that cause odours to form within a dishwasher is the residual food that remains trapped within the seals. Periodic cleaning with a damp cloth will prevent this from occurring.

Troubleshooting

GENERAL TROUBLESHOOTING STEPS

Having an issue with your dishwasher? Before contacting our service team, please refer to the troubleshooting table below. Most issues can easily be rectified with some basic troubleshooting.

| Problem | Possible Causes | Actions to try |
|---|---|---|
| My dishwasher won't start | <p>Fuse blown, or the circuit breaker has tripped.</p> <p>Power supply is not turned on.</p> <p>Water pressure is low.</p> <p>Door of dishwasher not properly closed.</p> | <p>Replace fuse or reset circuit breaker. Remove any other appliances sharing the same circuit with the dishwasher.</p> <p>Make sure the dishwasher is turned on and the door is closed securely. Make sure the power cord is properly plugged into the wall socket.</p> <p>Check that the water supply is connected properly and the water tap is turned on fully.</p> <p>Make sure to close the door properly and click it closed. Sometimes the incorrect loading of the basket racks can cause them to prevent the door from closing fully.</p> |
| The water is not draining from my dishwasher | <p>Twisted or trapped drain hose.</p> <p>Filter clogged.</p> <p>Kitchen sink or waste pipe is clogged.</p> | <p>Check the drain hose.</p> <p>Check coarse the filter.</p> <p>Check the kitchen sink to make sure it is draining well. If the problem is the kitchen sink that is not draining, you may need a plumber rather than a serviceman for dishwashers.</p> |
| Suds are remaining within the dishwasher base | <p>Wrong detergent.</p> <p>Spilled rinse-aid</p> | <p>Use only the special dishwasher detergent to avoid suds. If this occurs, open the dishwasher and let suds evaporate. Add 3-4 litres of cold water to the bottom of the dishwasher.</p> <p>Close the dishwasher door, then select any cycle. Initially, the dishwasher will drain out the water.</p> <p>Open the door after draining stage is complete and check if the suds have disappeared. Repeat if necessary.</p> <p>Always wipe up rinse-aid spills immediately</p> |
| Stained tub interior | Detergent with colourant may have been used. | Make sure that the detergent has no colourant. Refer to interior cleaning steps. |
| White film on inside surface | Hard water minerals. | To clean the interior, use a damp sponge with dishwasher detergent and wear rubber gloves. Never use any other cleaner than dishwasher detergent otherwise, it may cause foaming or suds. |
| There are rust stains on cutlery | The affected items are not corrosion resistant. | The items should be corrosion resistant. |
| Knocking noise in the dishwasher | A spray arm is knocking against an item in a basket | Interrupt the program and rearrange the items which are obstructing the spray arm. |
| Rattling noise in the dishwasher | Items of crockery are loose in the dishwasher. | Interrupt the program and rearrange the items of crockery. |



Troubleshooting (Continued)

| | | |
|-----------------------------------|---|---|
| Knocking noise in the water pipes | This may be caused by on-site installation or the cross-section of the piping. | This has no influence on the dishwasher function. If in doubt, contact a qualified plumber. |
| The dishes are not clean | <p>The dishes were not loaded correctly.</p> <p>The program was not powerful enough.</p> <p>Not enough detergent was dispensed.</p> <p>Items are blocking the movement of the spray arms.</p> <p>The filter combination is not clean or is not correctly fitted in the base of wash cabinet.</p> <p>This may cause the spray arm jets to get blocked.</p> | <p>See notes in "Loading & unloading your dishwasher".</p> <p>Select a more intensive program.</p> <p>Use more detergent, or change your detergent.</p> <p>Rearrange the items so that the spray can rotate freely.</p> <p>Clean and/or fit the filter correctly. Clean the spray arm jets.</p> |
| Cloudiness on glassware. | Combination of soft water and too much detergent. | Use less detergent if you have soft water and select a shorter cycle to wash the glassware and to get them clean. |
| Black or grey marks on dishes | Aluminium utensils have rubbed against dishes | Use a mild abrasive cleaner to eliminate those marks. |
| Detergent left in dispenser | Dishes block detergent dispenser | Re-loading the dishes properly. |
| The dishes aren't drying. | <p>Improper loading</p> <p>Too little rinse-aid</p> <p>Dishes are removed too soon</p> <p>Wrong program has been selected.</p> <p>Use of cutlery with a low-quality coating.</p> | <p>Load the dishwasher as suggested in the directions.</p> <p>Increase the amount of rinse-aid/refill the rinse-aid dispenser.</p> <p>Do not empty your dishwasher immediately after washing. Open the door slightly so that the steam can come out. Take out the dishes until the inside temperature is safe to touch. Unload the lower basket first to prevent the dropping water from the upper basket.</p> <p>With a short program, the washing temperature is lower, decreasing cleaning performance. Choose a program with a longer washing time or higher wash temperature. Try adding the Extra Drying function to your program.</p> <p>Water drainage is more difficult with these items. Cutlery or dishes of this type are not suitable for washing in the dishwasher.</p> |

Error Codes

If there is a malfunction the dishwasher will display error codes to identify the fault.

| Code Indicator | Meanings | Possible Causes |
|--|---|---|
| E1 will be displayed on the LED display and the buzzer will sound. | Water entering the dishwasher has exceeded the pre-set time, or the flow of water into the dishwasher is restricted. | Ensure that the water supply hose is un-kinked and that the water supply tap is fully open. |
| E3 will be displayed on the LED display and the buzzer will sound. | The dishwashers on board sensors have detected that the water isn't reaching the desired temperature within the pre-set time. | Potential malfunction of the heating element. Try turning the appliance power off at the power point for 15 minutes before re-starting. Also ensure the filter system is clean and free of foreign objects (such as broken glass). Check the drain hose isn't kinked or blocked. If issue persists, please contact our Customer Care team. |
| E4 will be displayed on the LED display and the buzzer will sound. | Overflow. The onboard computer has detected a leak (correctly or incorrectly). | Check that your dishwasher is level, an un-level dishwasher can trigger this alarm. If the problem persists Contact our Customer Care team. |
| E6 will be displayed on the LED display and the buzzer will sound. | Potential component failure. | Try turning the appliance power off at the power point for 15 minutes before re-starting. If issue persists, please contact our Customer Care team. |
| E7 will be displayed on the LED display and the buzzer will sound. | Potential component failure. | Try turning the appliance power off at the power point for 15 minutes before re-starting. If issue persists, please contact our Customer Care team. |

WARNING! If the E4 Overflow error is occurring, turn off the main water supply at the tap as a pre-caution, before calling our Customer Care team.

Note. If there is water in the base of the dishwasher because of an overfill or small leak, the water should be removed before re-starting the dishwasher.



THIS PAGE IS INTENTIONALLY LEFT BLANK

Warranty

AUSTRALIAN WARRANTY TERMS & CONDITIONS DISHWASHERS

This document sets out the terms and conditions of the product warranties for Residentia Group Appliances. It is an important document. Please keep it with your proof of purchase documents in a safe place for future reference should you require service for your Appliance.

1. IN THIS WARRANTY

(a) 'acceptable quality' as referred to in clause 10 of this warranty has the same meaning referred to in the ACL;

(b) 'ACL' means Trade Practices Amendment (Australian Consumer Law) Act (No.2) 2010;

(c) 'Appliance' means any Residentia Group product purchased by you accompanied by this document;

(d) 'ASR' means Residentia Group authorised service representative;

(e) 'Residentia Group' means Residentia Group Pty Ltd of 165 Barkly Avenue Burnley VIC, ACN 600 546 656 in respect of Appliances purchased in Australia;

(f) 'major failure' as referred to in clause 10 of this warranty has the same meaning referred to in the ACL and includes a situation when an Appliance cannot be repaired or it is uneconomic for Residentia Group, at its discretion, to repair an Appliance during the Warranty Period;

(g) 'Warranty Period' means:

(i) where the Appliance is used for personal, domestic or household use (i.e. normal single family use) as set out in the instruction manual, the Appliance is warranted against manufacturing defects for 24 months,

following the date of original purchase of the Appliance;

(h) 'you' means the purchaser of the Appliance not having purchased the Appliance for re-sale, and 'your' has a corresponding meaning.

2. This warranty only applies to Appliances purchased and used in Australia and is in addition to (and does not exclude, restrict, or modify in any way) any non-excludable statutory warranties in Australia.

3. During the Warranty Period Residentia Group or its ASR will, at no extra charge if your Appliance is readily accessible for service, without special equipment and subject to these terms and conditions, repair or replace any parts which it considers to be defective. Residentia Group or its ASR may use remanufactured parts to repair your Appliance. You agree that any replaced Appliances or parts become the property of Residentia Group. This warranty does not apply to light globes, batteries, filters or similar perishable/ consumable parts. This warranty does not cover any additional installation services, including replacing decorative door panels, kickboards, etc.

4. Parts and Appliances not supplied by Residentia Group are not covered by this warranty.

5. You will bear the cost of transportation, travel and delivery of the Appliance to and from Residentia Group or its ASR. If you reside outside of the service area, you will bear the cost of:

(a) travel of an authorised representative;

(b) transportation and delivery of the Appliance to and from Residentia Group or its ASR, in all instances, unless the Appliance is transported by Residentia Group or its ASR, the Appliance is transported at the owner's cost and risk while in transit to and from Residentia Group or its ASR.



Warranty (Continued)

6. Proof of purchase is required before you can make a claim under this warranty.

7. You may not make a claim under this warranty unless the defect claimed is due to faulty or defective parts or workmanship. Residentia Group is not liable in the following situations (which are not exhaustive):

- (a) the Appliance is damaged by:
 - (i) accident
 - (ii) misuse or abuse, including failure to properly maintain or service
 - (iii) normal wear and tear
 - (iv) power surges, electrical storm damage or incorrect power supply
 - (v) incomplete or improper installation
 - (vi) incorrect, improper or inappropriate operation
 - (vii) insect or vermin infestation
 - (viii) failure to comply with any additional instructions supplied with the Appliance;
- (b) the Appliance is modified without authority from Residentia Group in writing;
- (c) the Appliance's serial number or warranty seal has been removed or defaced;
- (d) the Appliance was serviced or repaired by anyone other than Residentia Group, an authorised repairer or ASR.
- (e) the maintenance guidelines within the product's user manual have not been followed (i.e. regular cleaning of the filters, etc).
- (f) the installation of the appliance is not in accordance with the guidelines within the product's user manual.

8. This warranty, the contract to which it relates and the relationship between you and Residentia Group are governed by the law applicable where the Appliance was purchased.

9. To the extent permitted by law, Residentia Group excludes all warranties and liabilities (other than as contained in this document) including liability for any loss or damage whether direct or indirect arising from your purchase, use or non use of the Appliance.

10. For Appliances and services provided by Residentia Group in Australia, the Appliances come with a guarantee by Residentia Group that cannot be excluded under the Australian Consumer Law. You are entitled to a replacement or refund for a major failure and for compensation for any other

reasonably foreseeable loss or damage. You are also entitled to have the Appliance repaired or replaced if the Appliance fails to be of acceptable quality and the failure does not amount to a major failure. The benefits to you given by this warranty are in addition to your other rights and remedies under a law in relation to the Appliances or services to which the warranty relates.

11. At all times during the Warranty Period, Residentia Group shall, at its discretion, determine whether repair, replacement or refund will apply if an Appliance has a valid warranty claim applicable to it.

12. To enquire about claiming under this warranty, please follow these steps:

- (a) carefully check the operating instructions, user manual and the terms of this warranty;
- (b) have the model and serial number of the Appliance available;
- (c) have the proof of purchase (e.g. an invoice) available;
- (d) telephone the numbers shown below.

13. You accept that if you make a warranty claim, Residentia Group and its ASR may exchange information in relation to you to enable Residentia Group to meet its obligations under this warranty.

IMPORTANT

Before calling for service, please ensure that the steps in point 12 have been followed.

Telephone contact

– Please call 1300 11 HELP (1300 11 4357)

Online portal

– <http://support.residentiaigroup.com.au>

THIS WARRANTY IS VALID IN AUSTRALIA ONLY.

The Australian Consumer Law requires the inclusion of the following statement with this warranty:

Our goods come with guarantees that cannot be excluded under the Australian Consumer Law. You are entitled to a replacement or refund for a major failure and for compensation for any other reasonably foreseeable loss or damage. You are also entitled to have the goods repaired or replaced if the goods fail to be of acceptable quality and the failure does not amount to a major failure.

Warranty (Continued)

NEW ZEALAND WARRANTY TERMS & CONDITIONS APPLIANCES

To help care for your investment, be sure to register your appliance online. Registration will help you if you need to arrange service in the future, and serves as a record of your purchase – including critical information like model number and serial number – that you can refer to at any time.

Simply visit the below website, or ask your retailer for help: www.inalto.co.nz/register

WARRANTY:

These products are covered by a warranty for a period of 24 months from the date of purchase, subject to the following conditions*. The warranty covers rectification free of charge of any fault arising from defective materials or components, or faulty workmanship or assembly.

* The conditions above mentioned are:

1. That the purchaser carefully follows all instructions packed with the product;
2. That the purchaser and/or installer carefully follows the installation instructions provided and complies with electrical wiring regulations, gas and/or plumbing codes;
3. That the purchaser carefully follows instructions provided in the owner's handbook relating to the proper use and care of the product and does not use the product for any purpose other than the domestic use for which it has been designed;
4. Commercial use of the product for professional or industrial purposes will void this warranty.;
5. That the product was purchased and installed in New Zealand;
6. That this warranty does not extend to:
 - a) optional glass lids for hobs apart from claims which relate to mechanical or physical damage thereof at the date of purchase;
 - b) 'consumable' parts such as light bulbs or filters;
 - c) damage to ceramic glass caused by liquid or solid spill-overs, lack of maintenance, or impact;
 - d) damage to surface coatings caused by cleaning or maintenance using products not recommended by the owner's handbook;
 - e) defects caused by normal wear and tear, accident, negligence, alteration, misuse or incorrect installations;
 - f) a product dismantled, repaired or serviced by any serviceman other than an authorised service agent;
 - g) a product not in possession of the original purchaser;
 - h) damage caused by power outages or surges
 - i) damage caused by pests (eg. rats, cockroaches etc.)
7. That if the product is a freestanding microwave oven or small appliance it must be returned to the dealer/retailer for servicing. These products, unless stated otherwise, have a 12 month warranty from original date of purchase with 24 months on the microwave magnetron; Waste disposers have a 12 month warranty.

8. The provision of service under this warranty is limited by a 25km boundary from the retailer where the product was purchased except for microwaves. Such travelling outside of these limits will incur commercial cost to be paid by you, regulated by the number of kilometres travelled beyond the 25km limit (50km return trip). Microwaves are to be delivered to the nearest authorised service agent by the customer.

Please refer to your user manual for any further conditions that may apply to your specific model.

Nothing herein contained shall be construed in any way as excluding or limiting your rights under the Consumer Guarantees Acts 1993.

For Service please visit www.applico.co.nz/service or contact the dealer/retailer from whom you purchased the product from or call the 0800 number listed below. If you are unable to establish the date of purchase, or the fault is not covered by this warranty, or if the product is found to be in working order, you will be required to bear all service call charges.

Registration of this warranty constitutes acceptance of the terms and conditions of this warranty. Should you require any assistance, please call Customer Services on 0800 763 448.

Distributed by Applico Ltd under licence from Residentia Group Pty Ltd.
www.applico.co.nz
July 2019

After registering your appliance online, we recommend you fill out the below information for your reference and keep this warranty card in a safe place.

THIS WARRANTY IS VALID IN NEW ZEALAND ONLY.



THIS PAGE IS INTENTIONALLY LEFT BLANK

A HIGHER LEVEL

INALTO?

OF COOKING

A RESIDENTIA
GROUP INITIATIVE



VERSION
1.3