



# STIRLING<sup>®</sup>

## Black Edition

# 7kg Heat Pump Clothes Dryer

**Model Number SHPD7**





## INSTRUCTION MANUAL

IM Version No.: V1.4

Issue Date: 07/2019

**AFTER SALES SUPPORT**

  1300 11 43 57

 [support@residentiagroup.com.au](mailto:support@residentiagroup.com.au)

MODEL: SHPD7 | PRODUCT CODE: 10426 | 07/2019



E2447

# Welcome

Congratulations on choosing to buy a STIRLING® product.

All products brought to you by STIRLING® are manufactured to the highest standards of performance and safety and, as part of our philosophy of customer service and satisfaction, are backed by our comprehensive 3 Year In Home Warranty. We hope you will enjoy using your purchase for many years to come.

# Contents

- 2** Welcome
- 5** Warranty
- 6** General Safety Warnings
- 8** Quick Start Guide
- 9** Product Overview
- 10** Controls
- 11** Installation Instructions
- 13** Getting Started
- 14** Operating Your Dryer
- 15** Program Table
- 16** Care & Maintenance
- 18** Troubleshooting
- 20** Technical Data
- 22** Repair and Refurbished Goods or Parts Notice
- 23** Warranty Returns

This page  
is intentionally  
left blank





 **STIRLING**<sup>®</sup>

7kg Heat Pump Dryer

## Warranty Details

---

REGISTER YOUR PURCHASE AT [www.aldi.com.au/en/about-aldi/product-registration/](http://www.aldi.com.au/en/about-aldi/product-registration/) TO KEEP UP-TO-DATE WITH IMPORTANT PRODUCT INFORMATION

---



The product is guaranteed to be free from defects in workmanship and parts for a period of 36 months from the date of purchase. Defects that occur within this warranty period, under normal use and care, will be repaired, replaced or refunded at our discretion. The benefits conferred by this warranty are in addition to all rights and remedies in respect of the product that the consumer has under the Competition and Consumer Act 2010 and similar state and territory laws.

Our goods come with guarantees that cannot be excluded under the Australian Consumer Law. You are entitled to a replacement or refund for a major failure and for compensation for any other reasonably foreseeable loss or damage. You are also entitled to have the goods repaired or replaced if the goods fail to be of acceptable quality and the failure does not amount to a major failure.



---

**AFTER SALES SUPPORT**

  1300 11 43 57

 [support@residentiagroup.com.au](mailto:support@residentiagroup.com.au)

MODEL: SHPD7 | PRODUCT CODE: 10426 | 07/2019

# General Safety Warnings

## **WARNING! Fire Hazard**

- Only dry fabrics that have been washed with water.
- Do not use heat to dry articles containing foam rubber or similarly textured rubber-like materials.
- Do not stop a tumble clothes dryer before the end of the drying cycle unless all items are removed and spread out in order to dissipate the heat.
- A clothes dryer produces combustible lint; the lint filter must be cleaned before each drying cycle.
- Failure to follow the warnings outlined in these user instructions can cause a fire hazard.
- Read all instructions carefully, even if you are quite familiar with the appliance. Failure to follow these instructions can result in death or personal injury.

When using this appliance always exercise basic safety precautions including the following:

## **DRYER USE**

- Do not use outdoors as this appliance is designed for indoor use only.
- The tumble dryer is intended only for drying textile material which has been washed in water.
- Undergarments that contain metal reinforcements should not be placed in the dryer. Damage to the dryer can result if the metal reinforcements come loose during drying. If you wish to dry these items, please use a drying rack or place in a garment bag.
- Check and remove all objects from clothing pockets, for example coins, lighters and matches.
- The maximum mass of dry textile material is seven kilograms. Do not overload your dryer.
- Never dry rubber articles, or any plastic items or film, eg plastic lined tablecloths and baby bibs.
- Clothes should go through the cool down/airing phase in the final part of the cycle. This ensures items are left at a temperature where they will not be damaged. If for any reason the dryer is stopped before the cycle has finished, dry clothes should be removed immediately and not left in the dryer. Clothes should be quickly spread out to be flat allowing heat to dissipate and clothes to cool. Avoid leaving clothes bunched up i.e. in a clothes basket.
- This dryer has been designed for domestic use only, not for commercial applications, where there may be increased lint accumulation or flammable materials in the atmosphere or load.
- Do not operate this product without the lint filters in place or allow lint to accumulate in or around the dryer.
- Only operate the appliance on a dry, level surface. Sinks, drainboards or uneven surfaces must be avoided.
- This dryer is not intended for use by persons (including children) with reduced physical, sensory or mental capabilities, or lack of experience and knowledge, unless given supervision or instruction concerning the use of the dryer by a person responsible for their safety.
- Children should be supervised to ensure they do not play with the dryer.
- Unplug the machine from the power supply when it is not in use.
- Do not operate the appliance if the power cord or plug is damaged, if it malfunctions or if it is dropped or damaged in any manner. Please contact our after sales service team.
- Do not allow the power cord to over-hang the edge of a table or counter, or touch hot surfaces.
- Do not operate or place any part of the appliance on or near any hot surfaces.
- Do not swing or put weight on the door.
- Your dryer is designed to stop operating in the event of power outage. When power is resumed, the machine will remain off until the 'POWER' button is pressed. To restart the dryer, press 'POWER', select your drying cycle and touch .
- Never attempt to repair the dryer yourself.
- The only user-removable parts of the dryer are the drain hose, lint filter, drying rack, condenser filter and the water tank. No other parts are designed to be removed by anyone other than an Authorised Repairer.
- For problems that cannot be solved from information in this User Guide, turn off and unplug your dryer and contact an Authorised Repairer.
- When disposing of the dryer, it is recommended that the door is removed to avoid children getting trapped inside, and that the electrical cable is cut off close to the dryer.
- Adequate ventilation has to be provided to avoid the back flow of gases into the room from appliances burning other fuels, including open fires.
- Exhaust air must not be discharged into a flue which is used for exhausting fumes from appliances burning gas or other fuels.
- **WARNING: The appliance must not be supplied through an external switching device, such as a timer, or connected to a circuit that is regularly switched on and off by a utility.**

**IMPORTANT! We do not recommend the use of extension cords or portable electrical outlet devices for safety reasons. If you are using an extension cord or portable electrical outlet device (eg multi-socket outlet box) ensure that it is positioned so that it does not come into contact with water or moisture.**

# General Safety Warnings Continued

## LINT

- Accumulated lint in the dryer can become a fire hazard; it also reduces the efficiency of the dryer by causing longer drying times and increased power consumption.
- Clean the lint filters after every load and ensure lint filters are clean and empty before beginning any new load. Allow for the appliance to cool before cleaning.
- Ensure the area around the dryer is clear of lint.
- At regular intervals have the interior of the dryer cleaned of any accumulated lint.

## SPONTANEOUS COMBUSTION

**IMPORTANT! To reduce the risk of fire in a tumble dryer the following should be observed:**













- Items that have been spotted or soaked with vegetable oil or cooking oil are a fire hazard and should not be placed in a tumble dryer.
- Oil-affected items can ignite spontaneously, especially when exposed to heat sources such as a tumble dryer. The items become warm causing an oxidation reaction in the oil. This oxidation creates heat. If the heat cannot escape the items can become hot enough to catch fire. Piling, stacking or storing oil-affected items can prevent heat from escaping creating a fire hazard.
- If it is unavoidable that fabrics that contain vegetable oil, cooking oil or have been contaminated by hair care products be placed in a tumble dryer, they should first be washed in hot water with extra detergent – this will reduce, but not eliminate the fire hazard. The cool down cycle of the dryer should be used to reduce the temperature of these items. They should not be removed from the tumble dryer and piled or stacked while hot.
- Items that have previously been cleaned in, washed in, soaked in or spotted with flammable liquids or solids, eg petrol/ gasoline, kerosene, dry cleaning solvents, vegetable or cooking oil, acetone, denatured alcohol, some brands of spot removers, turpentine, waxes and wax removers or other flammable or explosive substances should not be placed in a tumble dryer.
- Never dry unwashed items in the tumble dryer.
- The dryer is not to be used if industrial chemicals have been used for cleaning.
- Fabric softeners or similar products should not be used in a tumble dryer to eliminate the effects of static electricity, unless this practice is specifically recommended by the manufacturer of the fabric softener product.
- Rubber backed articles, foam rubber (latex foam), clothes or pillows fitted with foam rubber pads, fibreglass, shoes containing rubber, shower caps, babies waterproof napkin covers and waterproof textiles should not be dried in the dryer. These materials can when heated produce fire by spontaneous combustion.

## DISPOSAL

- Extreme care must be taken when disposing of your old appliance to avoid hazards.

## DRY CARE SYMBOLS

Please pay attention to use the drying machine if the materials of your clothes can not be dried by it or contain the symbols as follows:

 Dry	 Normal	 Not tumble dry normal	 Do not dry	 Dry clean normal cycle with any solvent	 Dry clean normal cycle petroleum solvent only
 Line dry / hang to dry	 Drip dry	 Dry flat	 In the shade	 Dry clean	 Do not dry clean



## USAGE CONDITIONS, RESTRICTIONS AND INSTALLATION

- Domestic use only: this appliance is intended for indoor household use only. It is not intended for industrial, commercial or trade use. Do not use it outdoors. Do not use it for anything other than its intended purpose (drying domestic quantities of washing), and only use it as described in this manual.
- The appliance must not be installed behind a lockable door, a sliding door or a door with a hinge on the opposite side to that of the dryer, in such a way that a full opening of the dryer door is restricted.
- **WARNING: The appliance must not be supplied through an external switching device, such as a timer, or connected to a circuit that is regularly switched on and off by a utility.**



This symbol alerts you to take care as oil-affected items can ignite spontaneously, especially when exposed to heat, such as in a clothes dryer. The items become warm, causing an oxidation reaction in the oil. Oxidation creates heat. If the heat cannot escape, the items can become hot enough to catch fire. Piling, stacking or storing oil-affected items can prevent heat from escaping and so create a fire hazard.

## AFTER SALES SUPPORT

  1300 11 43 57

 [support@residentiagroup.com.au](mailto:support@residentiagroup.com.au)

MODEL: SHPD7 | PRODUCT CODE: 10426 | 07/2019

# Quick Start Guide

## FOLLOW THESE STEPS TO GET STARTED QUICKLY.

- Check the lint filter is clean and the water tank is empty before every load. Ensure both are replaced correctly before using your dryer. The lint filter indicator will be on when the machine is on as a reminder to check the lint filters.
- Sort and load items into the dryer drum, ensuring no items are in the way of the door. Close the door (you will hear it click shut).

1. Press 'On/Off' to activate your dryer.
2. Select your desired drying cycle by turning the Program Selection Dial.
3. Select your preferred drying options, using the buttons on the right hand side of the panel (if you wish to select options different from the default options for the cycle).
4. Touch the 'Start/Pause' button to start the cycle.

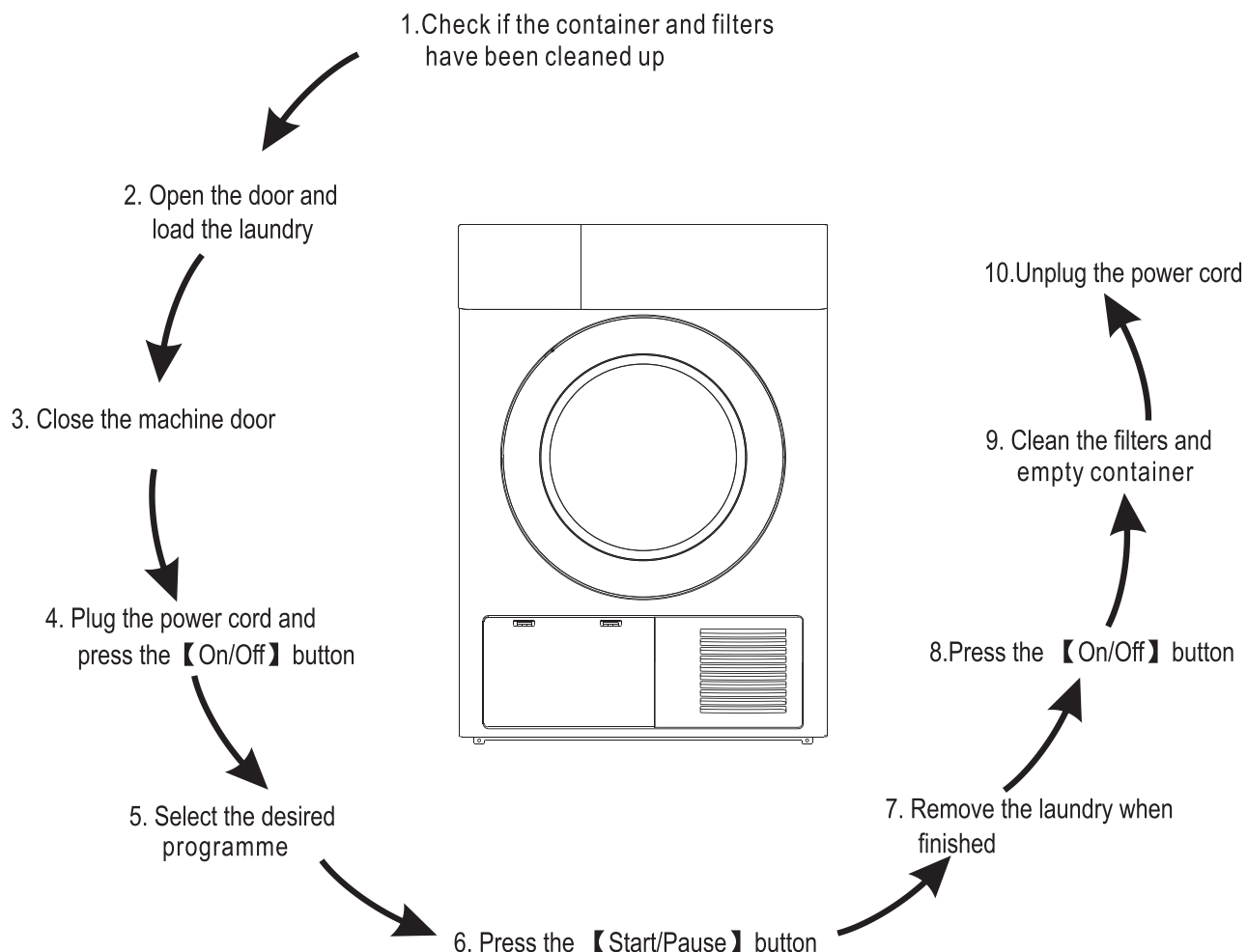

# Product Overview

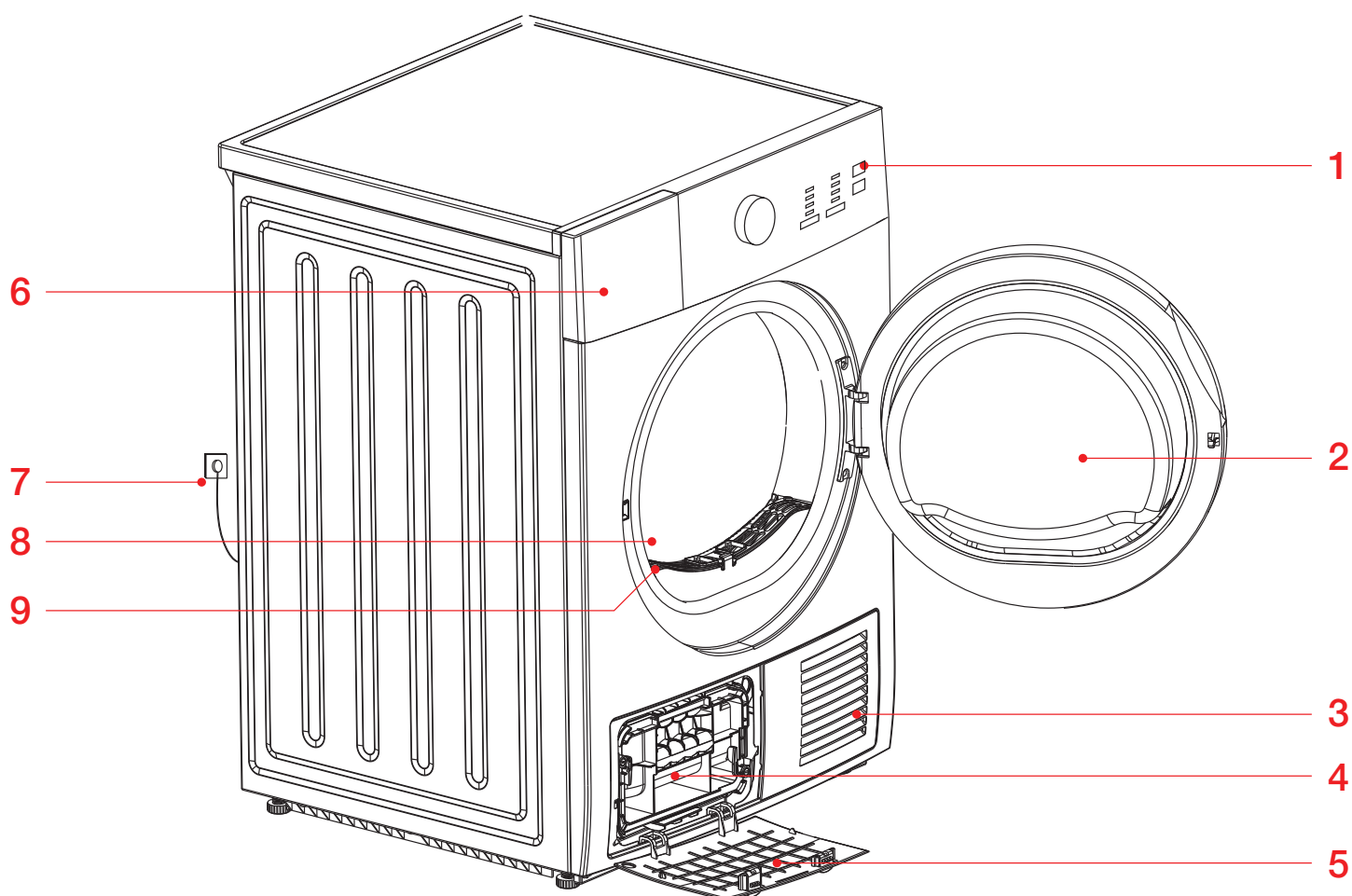

## KEY

- |                  |                      |                |
|------------------|----------------------|----------------|
| 1. Control Panel | 4. Handle            | 7. Power Cord  |
| 2. Door          | 5. Maintenance Cover | 8. Drum        |
| 3. Air Inlet     | 6. Water Reservoir   | 9. Lint Filter |

# Controls

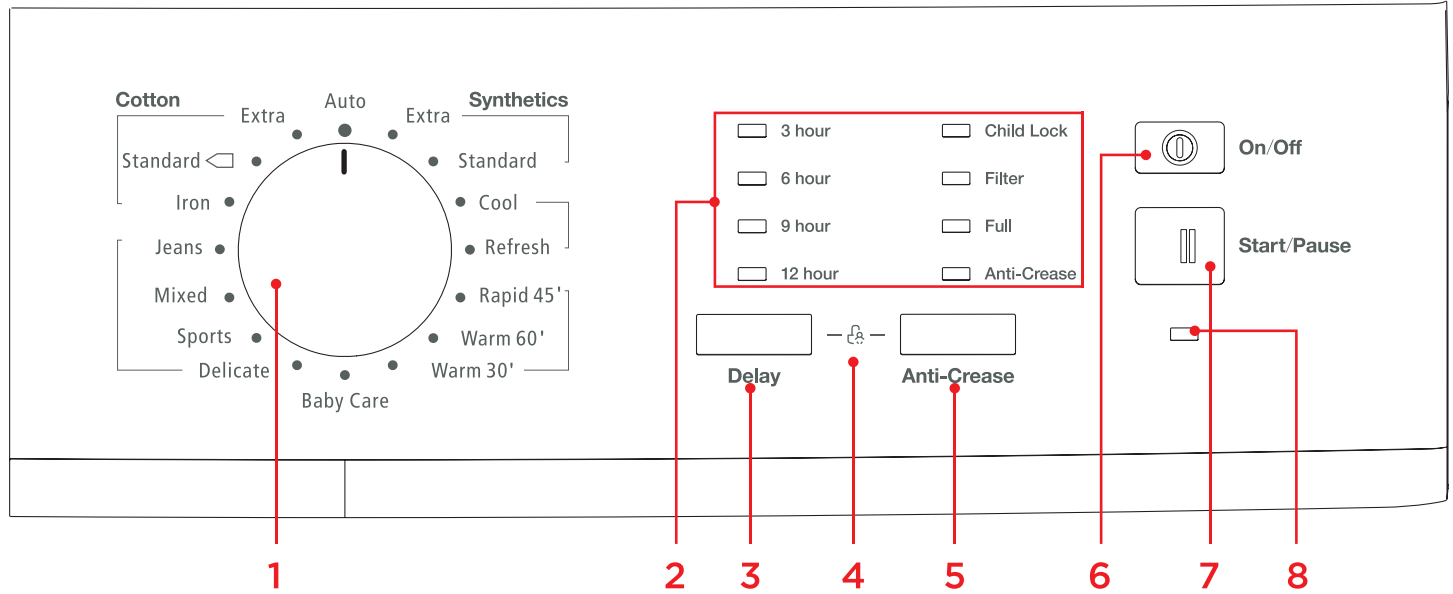

## KEY

- |                            |                             |                       |
|----------------------------|-----------------------------|-----------------------|
| 1. Program Selector Knob   | 4. Child Lock (see page 14) | 7. Start/Pause button |
| 2. Function LED Indicators | 5. Anti-crease              | 8. Power Indicator    |
| 3. Delay                   | 6. On/Off button            |                       |

# Installation Instructions

Please read and follow the 'Safety and warnings' and 'Installation instructions' sections carefully before using your dryer!

## TRANSPORT

Move your packaged appliance carefully and note the front, back and sides as indicated on the appliance box. If the dryer cannot be transported in the erect position, the dryer should be slanted at less than 30° from the right hand side (when viewed from the front).

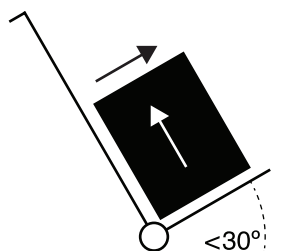

## MOVING YOUR APPLIANCE

If the dryer needs to be placed at an angle for moving, only angle towards the right hand side (when viewed from the front). If the dryer has not been transported as described, leave it standing upright for at least one hour before turning on. Accessories Please check you received the following accessories with your dryer. You will find them inside the drum:

- 1 x Bypass hose (drain hose)
- 1 x Installation instructions and user guide

## UNPACKING

To ensure the best performance from your new dryer please follow the instructions below.

Removing the packaging

1. Remove the outer packaging (including the polystyrene packer and plastic wrapping). All packaging must be removed prior to use.
2. Tilt the machine backwards and 'walk' it off the base one foot at a time. Not doing so may cause damage to your floor and dryer.
3. Remove all packaging and accessories from inside the drum and ensure you remove protective covers from door and console.

## IMPORTANT!

- Ensure packaging materials are kept out of reach of children, as bags present suffocation risks.
- Please help protect the environment and dispose of the packaging from around the dryer in an environmentally friendly manner.

## INSTALLATION POSITION

Give some consideration to the location/position of your dryer and follow the following important requirements:

- The dryer must be installed in a well-ventilated and dust-free environment.
- The dryer must not be installed on any textured floor coverings (eg carpet, rugs) to ensure that openings at the base of the machine are not obstructed. For this reason, you must not remove the feet.
- To keep vibration and noise to a minimum during use, please ensure that the floor is solid and level.
- Air must be able to circulate freely all round the appliance. Do not obstruct the front air inlet or the air intake grills at the back of the machine.
- Do not install the dryer behind a lockable door, sliding door, or behind a door where the hinge is on the opposite side to that of the dryer in such a way that the full opening of the door is inhibited. Ensure the dryer door can always be opened fully.
- It is recommended that, for your convenience, the machine is positioned close to your washing machine.

Note: this dryer CANNOT BE INVERTED AND MOUNTED ON THE WALL.

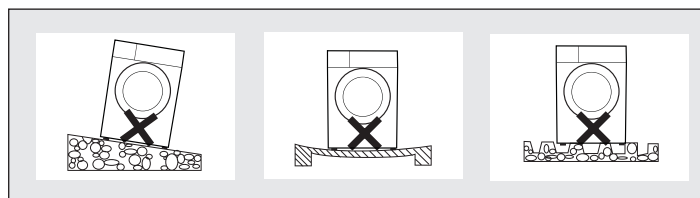

## INSTALLATION OPTIONS

Your dryer can be installed one of two ways, either freestanding, or stacked on top of a compatible front loading washing machine. Please contact our After Sales Support team on 1300 11 4357 for advice on this.



### FREE STANDING

The dryer stands on the floor and can easily be moved into position. Follow the installation position guidelines.

### STACKING

Your dryer has been designed to be able to be stacked on top of a compatible front loading washing machine. A stacking kit MUST BE USED between the products and fitted correctly to the washing machine and dryer, as per the stacking kit instructions. Contact the After Sales Service team on 1300 11 4357 to inquire about purchasing the stacking kit.

## AFTER SALES SUPPORT

  1300 11 43 57

 [support@residentiagroup.com.au](mailto:support@residentiagroup.com.au)

MODEL: SHPD7 | PRODUCT CODE: 10426 | 07/2019



# Installation Instructions Continued

1. Move the machine into the desired position. Do not lift the dryer by the top panel.
2. Have a minimum clearance on all sides of at least 20 mm.
3. Install the machine on a stable and level floor (if not stacking on top of a front loading washer).

- Do not install your dryer in such a way that the dryer door cannot be opened fully.
- Do not install the dryer outside, in a damp place, where there is a risk of freezing, where it may be rained on, in direct sunlight or close to a source of heat.
- Do not place your machine on top of its power cable.

## LEVELLING THE MACHINE

It is **IMPORTANT** to level the machine to ensure the machine runs efficiently with minimal noise. The dryer should be levelled in as close to its final position as possible so it stands balanced evenly on all four feet. Ensure the dryer does not rock in any direction.

The dryer comes with four adjustable feet, wind all four feet up or down until the dryer is correctly level. Use a tool as required, to assist with unscrewing or screwing the legs. A spirit level can also assist with this process. The machine is considered level when the bubble sits in the centre (i.e. within the two lines or the circle), when the spirit level is placed flat on top of your dryer, in the directions from:

1. left to right,
2. back to front and
3. corner to corner.

Never unscrew the feet completely from their housings.

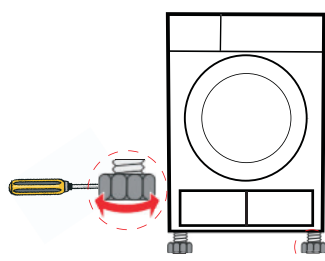

Note: after levelling, the corners of the dryer cabinet should be clear of the floor and the machine must not rock in any direction.

## DRAINING

The dryer is equipped with a condenser unit which accumulates water during the drying cycle. This water is collected in the removable water tank located at the top left of the dryer. The accumulated water must be emptied after each drying cycle.

However you can also set up your dryer to drain automatically using the bypass hose (drain hose) provided.

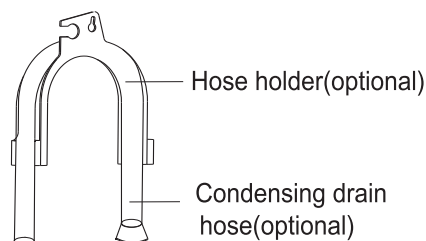

1. Remove the drain hose from the hose connector using pliers. (Fig. 1)
2. Insert the external drainage hose. (Fig. 2)
3. Put the hose holder on the washing basin or any other sink. (Fig. 3)

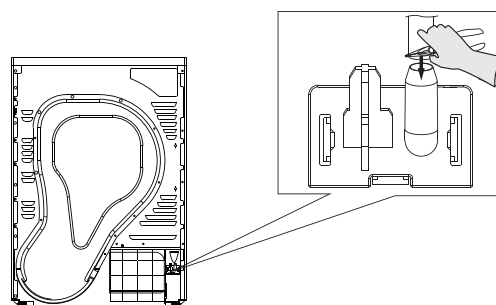

(Figure 1)

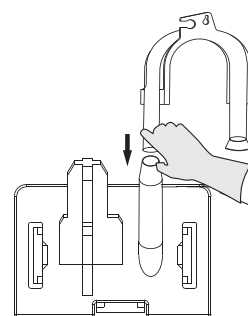

(Figure 2)

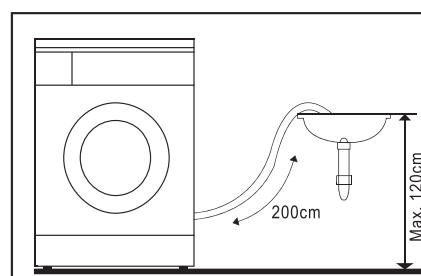

(Figure 3)



# Getting Started











Once your dryer is installed, please follow these steps before first use.

1. Place a small amount of fabric (such as clean rags) into the drum.
2. Plug the dryer into its power point and switch the power point on.
3. Press the On/Off button.
4. Select the Refresh Program, press the Start/Pause button.
5. After the completion of this program, please follow the "Cleaning and Care" Instructions within this user manual, to clean the lint filter.

## GENERAL ADVICE

- Before drying clothes, ensure that they have been thoroughly spun within the washing machine to remove as much water as possible. This will reduce the drying time and save energy consumption.
- Before drying, please close any zips, hooks and eyelets, button up, tie fabric belts, etc.
- Avoid over drying the clothes, as this can lead to creases and/or shrinkage.
- Do not dry the articles containing rubber or similar elastic materials such as raincoats, bicycle covers, etc.
- The door can be opened only after the program of the drying machine is completed. Do not open the door before the program finished, as the skin may be scalded by steam or a hot surface.
- Clean the lint filter and empty the water container after each use.
- The compressor and heat pump during operation will create some noise which is entirely normal.
- Please choose the related program designed for your relevant clothes choice.

The weight references as follows:

Blended Coats (about 800g)		Jackets (about 800g in cotton)	
Single Sheets (about 600g in cotton)		Work Clothes (upper and lower) (about 1120g in cotton)	
Undershirts (about 180g in cotton)		Underpants (about 70g in cotton)	
Jeans Trousers (about 800g)		Towel Quilts (about 900g in cotton)	
Pajamas (about 200g)		Shirts (about 300g in cotton)	
Socks (about 30g in blended material)			

# Operating Your Dryer

## SELECTING THE PROGRAM

1. Press the On/Off button. The LED display will switch on to indicate the dryer is on.
2. Rotate the drying program knob to select your desired drying program.
3. As additional options, you can select Delay, or Anti-crease functions.
4. To begin drying using your selected settings, press the Start/Pause button. The dryer door will lock and begin its program.

## NOTE:

Occasionally during operation the spinning drum may pause for approximately 40 seconds during the drying procedure, but the LED display will continue as normal. The dryer is automatically adjusting in this time and will continue operation.

## PROGRAM END

1. The drum will stop spinning at the completion of the program. The LED display will remain alight and a brief audible sound will indicate the program is complete. Both the "Filter" and "Full" LED indicators will remind you to clean the lint filters and water container. The dryer will start Anti-crease function if you don't remove the clothes in time. Please press the On/Off key to cut off power and remove the plug from your power point.
2. If there is an unexpected error or malfunction, the dryer will pause and alert you to an issue. In this case, please deal with the problem according to the "Troubleshooting" section.

## SPECIALTY DRYING FUNCTIONS

### Delay Function

1. Load your laundry and make sure the dryer door is closed.
2. Press the On/Off button, then turn the program selector knob to select your desired program.
3. At this stage, you can select the Anti-Crease function according to your need.
4. Press the Delay button.
5. Continue to press the Delay to select the desired delay time.
6. After the Start/Pause button is pushed, the dryer is at the run condition. The drying procedure will be automatically performed when the delay time is over.
7. If you push the Start/Pause button again, the delay function will be paused.
8. If you want to cancel the "Delay" function, please press the On/Off button.

### Anti-Crease Function

At the end of the drying cycle, the anti-crease operation time is 30 minutes (default) or 120 minutes (selected).

The Anti-Crease LED shall light when the anti-crease function is selected. This function prevents the laundry from creases. The clothing can be removed during the anti-crease phase and all other drying programs except for Cool, Refresh, Warm 30' and Warm 60'.

### CHILD LOCK

1. This machine incorporates a special child safety lock, which can prevent children from carelessly pressing buttons or changing the selected settings.
2. When the dryer is in operation, press both the AntiCrease and Delay buttons at the same time for 3 seconds to turn on the child lock function. When the child lock function is set, no buttons or dials can alter the selected settings, except the On/Off button. To deactivate the Child Lock, simply press both the Anti-Crease and Delay buttons at the same time for 3 seconds.

# Program Table

Programme		Weight (max)	Application/Properties
Auto	Auto	5.0kg	To dry unknown material clothes automatically.
Cotton	For cottons and coloureds made of cotton or linen.		
	Extra	7.0kg	To dry cotton pieces of clothing. Drying level: extra dry.
	Standard	7.0kg	To dry cotton pieces of clothing. Drying level: cupboard dry.
	Iron	7.0kg	To dry cotton pieces of clothing. Drying level: applicable to iron.
Jeans	Jeans	5.0kg	To dry jeans or leisure clothes that are spun at high speeds in the washing machine.
Mixed	Mixed	3.5kg	If you can not determine what the clothing's material is, please choose Mix.
Sports	Sports	3.0kg	To dry sportswear, thin fabrics, polyester, which are not ironed.
Delicate	Delicate	1.0kg	To dry delicate laundry that is suitable for drying or laundry which is advised to be hand-washed at a lower temperature.
Baby Care	Baby Care	1.0kg	To dry small amount of baby clothing.
Synthetics	For non-iron washing made of synthetic and blended fabrics, cotton.		
	Extra	3.5kg	To dry thick or multi-layered synthetic fabrics. Drying level: extra dry.
	Standard	3.5kg	To dry thin synthetic fabrics which are not ironed, such as easy care shirts, table linen, baby clothes, socks.
Cool	Cool	—	To air clothes without blowing hot air from in 10 min.
Refresh	Refresh	—	To refresh the clothes that have been kept at closed environments for a long time from minimum 20 min. to maximum 150 min. (in 10 min. steps).
Rapid 45'	Rapid 45'	0.6kg	To dry at most 3 shirts in 45 min.
Warm 60'	Warm 60'	—	To warm clothes with hot air in 60 min.
Warm 30'	Warm 30'	—	To warm clothes with hot air in 30 min.

## NOTE:

1. Cotton + Extra was used for AS/NZS energy program.
2. The programs above are only recommended for using, users can choose the appropriate program according to the personal habits. Thick and multi-layered fabrics, e.g. bedlinen, jeans, jackets etc, are not easy to dry and we recommend choosing the Jeans program combined with the maximum drying intensity level.
3. As uneven materials, thick and multi-layered clothes are not easy to dry, it is better to choose the appropriate time drying program to dry them if some parts of the clothes still damp after the program has finished.

# Cleaning & Maintenance

## EMPTYING THE WATER COLLECTION TANK

Follow this process to empty the dryers' water collection tank.

1. Hold and pull out the water tank with two hands.
2. Tilt the water tank to pour the waste water into your sink.
3. Re-install the water collection tank into your dryer by sliding into its housing.

### WARNING:

1. Remember to empty the water container after each use. Note: If the water container reaches maximum capacity during operation, the drying program will pause and the Full LED indicator will be displayed to alert you to empty the container. Once the container has been emptied and re-installed, the dryer can be restarted by pressing the Start/Pause button.
2. Never drink the condensed water or use within food processing.
3. Do not operate the dryer without the water container installed, unless the bypass hose (drain hose) has been installed.

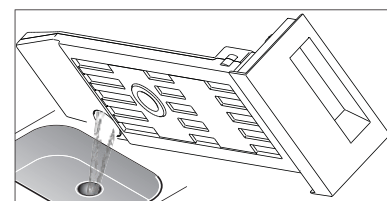
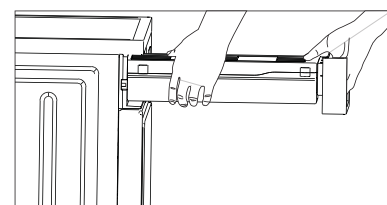

## CLEANING THE LINT FILTER

It's important that after every use the lint filter located inside the door is emptied and cleaned. Follow this process:

1. Open the door.
2. Remove the filter by pulling it upwards.
3. Open the filter and clean by removing any lint which has accumulated within. You can use your hands or a cloth to gently wipe the lint filter.
4. Close the lint filter and reinstall into its position just inside the door.

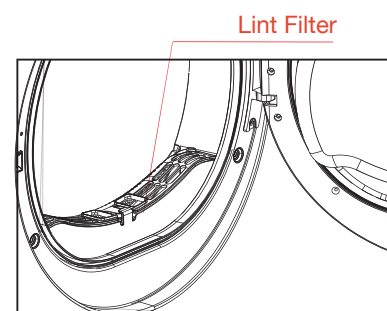

## CLEANING THE BASE FILTER

It's important that after every four or five uses, the base filter is checked and cleaned. Follow this process:

1. Open the maintenance cover.
2. Unscrew both locking levers toward each other and remove the base filter.
3. Clean the filter completely by wiping with a cloth.
4. Re-insert the base filter and lock in place with the locking levers.
5. Close the maintenance cover until it locks into position.

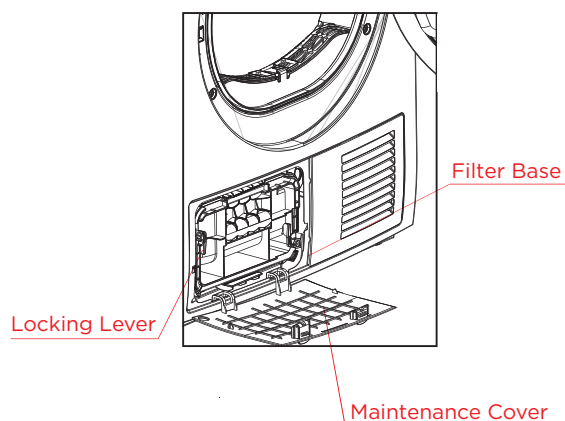

### WARNINGS!

- Failure to clean the filters of accumulated lint will block the air circulation and effect the performance of your dryer (in terms of drying time and energy consumption). It can also present a fire risk!
- Always disconnect the power cord before commencing cleaning and ensure the dryer has cooled down from any recent operation.
- Never operate the dryer without the filters installed correctly!
- Clean the filter after each use to prevent lint accumulation inside the dryer.

## CLEANING THE HEAT EXCHANGER

Depending on the amount of use (based on regular weekly use we recommend this process is undertaken every two months), remove the fluff from the heat exchanger using a sponge or soft brush. Note the lint can be removed more easily by using a slightly dampened sponge. Always use gloves.

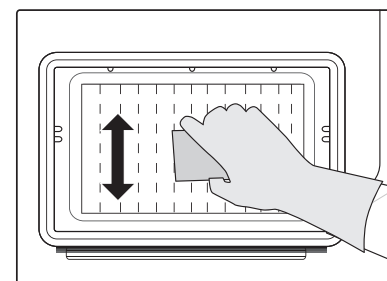

# Cleaning & Maintenance Continued

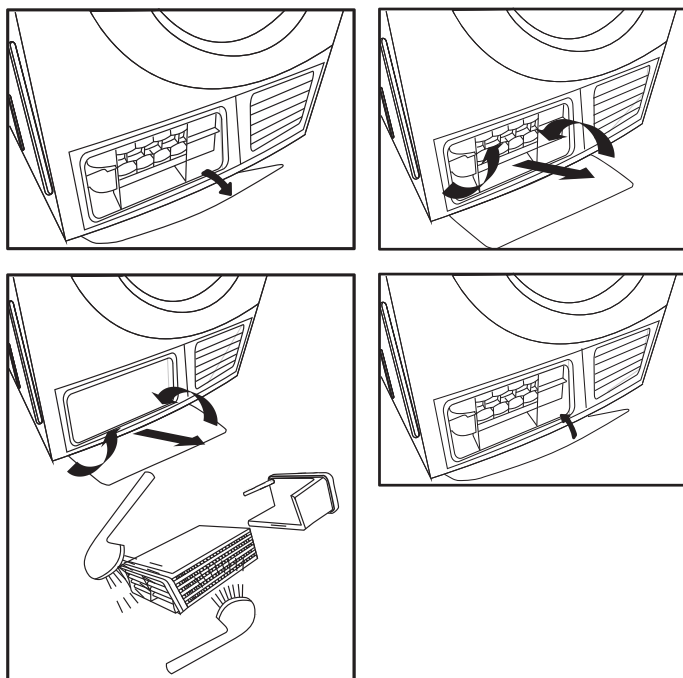

## WASHING THE AIR CONDENSER

If you use your dryer frequently (i.e. several times each week), we recommend that you wash the air condenser every 3 months. This is a fragile component so please be careful not to damage the air condenser during cleaning.

Please follow these steps:

1. Allow the dryer to cool down.
2. Place an old towel down on the floor near the maintenance cover, as residual water may flow out.
3. Open the maintenance cover.
4. Open both the locking levers by unscrewing toward each other.
5. Remove the Air Condenser.
6. Clean the Air Condenser with water only and avoid using sharp edged objects. Allow the Air Condenser to thoroughly drain and dry.
7. Re-install the Air Condenser and lock in place with the levers.
8. Close the maintenance flap until it locks in to place.

# Troubleshooting

Your dryer is capable of diagnosing a number of its own problems. It will sound a continuous series of beeps and display a code to alert you that it has a problem that you can correct yourself. To stop the beeps sounding, press any button on the control panel. Please do not try to continue your drying cycle once you stop the alert. You must address the problem the dryer is alerting you to by referring to this chart. If you are unable to address your fault by the troubleshooting steps below, please contact our After Sales Service team on 1300 11 4357 for further advice.

## ERROR DISPLAYS

DISPLAY	PROBLEM	SOLUTION
"FULL"	The water collection tank is full and needs to be emptied.	Check whether the water collection tank is full and empty waste water.
		If using the bypass hose (drain hose), check whether the water tank or drain hose is blocked.
		If using the bypass hose (drain hose), check that the hose is still attached at the back of the machine, and has not become kinked or squashed.
Child Lock + "9h"	Temperature sensor failure	Please contact our after sales service team.
Child Lock + "6h"	Humidity sensor failure	Please contact our after sales service team.
Child Lock + "3h"	Heater failure	Please contact our after sales service team.

## TROUBLE SHOOTING

DISPLAY	PROBLEM	SOLUTION
Pressing the 'On/Off' button does not turn on the dryer. "FULL"	Fault with the household power supply or fuse.	Try plugging in another electrical appliance in the same power point and testing.
Dryer does not heat.	Is your dryer set to the 'Cool' or 'Refresh' programs?	Refer to this manual for the various drying programs and try using an alternative program.
	The dryer may have completed its drying portion of the cycle and now cooling down the clothes?	-
	The water tank may be full?	Empty the water tank.
Pressing the Play/Pause button does not start the drying program.	The door may be open or not completely closed?	Check the door is closed completely.
	The water tank may not be completely inserted.	Remove the water collection tank and re-insert fully.
	The dryer may be experiencing an error.	Refer to the error displays section above.
	Delay start may be activated?	Check to ensure you haven't inadvertently set a delay timer for the dryer to begin.
	Lint filter may be full.	Check the lint filter has been emptied.
	Dryer may be overloaded with clothing.	Check to ensure the dryer hasn't been overloaded and try removing some clothing.

# Troubleshooting Continued

DISPLAY	PROBLEM	SOLUTION
The dryer stops working mid cycle	Power supply failure?	Press the On/Off button, select your drying program and press Play/Pause.
	Dryer has been paused?	Press the Play/Pause button to resume.
	Dryer door is open?	Ensure the door is completely closed.
Dryer is taking too long and/or the drying results were not satisfactory	Drying program selected is not suitable for the load or clothing type.	Refer to the drying program guide within this user manual and try alternative programs.
	Dryer is overloaded.	Ensure the dryer is not being overloaded according to the selected drying program and clothing type.
	Lint filter is blocked.	Refer to the Cleaning and Maintenance section.
	Condenser filter is blocked.	Refer to the Cleaning and Maintenance section.
	Load overly wet before being loaded into the dryer.	Try increasing your spin speed settings on your washing machine to remove more water from the clothing before drying.
	Environmental conditions may be effecting performance.	In hot and/or humid environments, the dryers performance will not be as efficient and will take longer.
Small amount of water is pooling below dryer	Dryer is not level.	Use a spirit level to check that the dryer is level and stable.
	Door seals are not clean or are damaged.	Use a cloth to clean the door seals from any lint build up. If your door seals are damaged, please contact our after sales service team.
	Water tank is full.	Empty the water collection tank and re-install.
	Water tank is not correctly installed.	Remove the water collection tank and re-fit fully.
	Bypass hose (drain hose) has become disconnected at rear, or damaged.	Check the bypass hose at the rear and ensure that it is still fitted correctly and free from damage.
	Drain may be blocked.	Check that your drain is working and unblocked.
Clothes are getting too hot or damaged.	Cycle selected not appropriate for the load.	Select the appropriate drying program and settings for your clothing types.
	Clothes are being removed from the dryer before the drying program has been completed (i.e. allowing the cool down to occur).	Allow the drying program to complete it's cycle. If you need to remove clothes before completion, it's important to lay clothing out to allow the heat to dissipate.
Noises & Vibration	Your dryer may be overloaded.	Ensure that the dryer isn't overloaded.
	Your dryer may not be level.	Ensure that the dryer is installed level and on a flat surface. Adjust the feet as required.

# Technical Data

<b>PARAMETER</b>	<b>MODEL</b> <b>SHPD7</b>
Dimension(L *W*H)	622*595*845(mm)
Ambient temperature	+5°C ~ +35°C
Rated input power	850W
Rated voltage	220-240V~
Rated frequency	50Hz
Refrigerant	R134a
Weight of product	51kg
Rated capacity	7.0kg

**Contains fluorinated greenhouse gases covered by the Kyoto Protocol. Hermetically sealed.**

**NOTE:**

1. The rated capacity is the maximum capacity. Please make sure that the dry clothes which are loaded to the appliance do not exceed the rated capacity each time.
2. Do not install the tumble dryer in a room when there is a risk of frost occurring. At temperatures around freezing point the tumble dryer may not be able to operate properly.
3. There is a risk of damage if the condensed water is allowed to freeze in the pump, hoses and/ or condensed water collection tank.



This page  
is intentionally  
left blank



 **STIRLING**<sup>®</sup>

**7kg Heat Pump Dryer**

# Repair and Refurbished Goods or Parts Notice

Unfortunately, from time to time, faulty products are manufactured which need to be returned to the Supplier for repair.

Please be aware that if your product is capable of retaining user-generated data (such as files stored on a computer hard drive, telephone numbers stored on a mobile telephone, songs stored on a portable media player, games saved on a games console or files stored on a USB memory stick) during the process of repair, some or all of your stored data may be lost.

**We recommend you save this data elsewhere prior to sending the product for repair.**

You should also be aware that rather than repairing goods, we may replace them with refurbished goods of the same type or use refurbished parts in the repair process.

**Please be assured though, refurbished parts or replacements are only used where they meet ALDI's stringent quality specifications.**

If at any time you feel your repair is being handled unsatisfactorily, you may escalate your complaint. Please telephone us on 1300 11 43 57 or write to us at:

Residentia Group  
165 Barkly Avenue, Burnley  
VIC 3066 Australia

Email: [support@residentiagroup.com.au](mailto:support@residentiagroup.com.au)

Helpline hours of operation:  
Mon–Fri  
9:00 AM - 5:00 PM





## Warranty returns

Should you for any reason need to return this product for a warranty claim, make sure to include all accessories with the product.

## Product does not work?

If you encounter problems with this product, or if it fails to perform to your expectations, make sure to contact our After Sales Support Centre on 1300 11 4357.



For an electronic copy of this manual, go to [www.stirlingappliances.com.au](http://www.stirlingappliances.com.au) and download a copy.

Limited Edition



---

**AFTER SALES SUPPORT**

  1300 11 43 57

 [support@residentiagroup.com.au](mailto:support@residentiagroup.com.au)

MODEL: SHPD7 | PRODUCT CODE: 10426 | 07/2019