



STIRLING[®]

Black Edition

6kg Front Load Washing Machine

Model Number SFLW6





INSTRUCTION MANUAL

IM Version No.: V1.2

Issue Date: 07/2019

AFTER SALES SUPPORT

  1300 11 43 57

 support@residentiagroup.com.au

MODEL: SFLW6 | PRODUCT CODE: 10018 | 07/2019



E2447

Welcome

Congratulations on choosing to buy a STIRLING® product.

All products brought to you by STIRLING® are manufactured to the highest standards of performance and safety and, as part of our philosophy of customer service and satisfaction, are backed by our comprehensive 3 Year In Home Warranty. We hope you will enjoy using your purchase for many years to come.

Contents

- 2** Welcome
- 5** Warranty
- 4** General Safety Warnings
- 5** Your Washing Machine
- 6** Installation Instructions
- 8** Washing Your Clothes
- 10** Quick Start Guide
- 11** Controls
- 12** Operating Your Washing Machine
- 14** Maintenance
- 19** Troubleshooting
- 22** Care Label
- 23** Technical Data
- 24** Repair and Refurbished Goods or Parts Notice
- 25** Warranty Returns

This page
is intentionally
left blank



STIRLING[®]

6kg Front Load Washing Machine

Warranty Details

REGISTER YOUR PURCHASE AT www.aldi.com.au/en/about-aldi/product-registration/ TO KEEP UP-TO-DATE WITH IMPORTANT PRODUCT INFORMATION

The product is guaranteed to be free from defects in workmanship and parts for a period of 36 months from the date of purchase. Defects that occur within this warranty period, under normal use and care, will be repaired, replaced or refunded at our discretion. The benefits conferred by this warranty are in addition to all rights and remedies in respect of the product that the consumer has under the Competition and Consumer Act 2010 and similar state and territory laws.

Our goods come with guarantees that cannot be excluded under the Australian Consumer Law. You are entitled to a replacement or refund for a major failure and for compensation for any other reasonably foreseeable loss or damage. You are also entitled to have the goods repaired or replaced if the goods fail to be of acceptable quality and the failure does not amount to a major failure.



General Safety Warnings

- If the supply cord is damaged, it must be replaced by the manufacturer, its service agent or similarly qualified persons in order to avoid a hazard.
- The new hose-sets supplied with the appliance are to be used and the old hose-sets should not be reused.
- This washing machine is for indoor use only.
- Do not install this appliance on a carpet surface.
- This appliance is not intended for use by persons (including children) with reduced physical, sensory or mental capabilities, or lack of experience and knowledge, unless they have been given supervision or instruction concerning use of the appliance by a person responsible for their safety. Children should be supervised to ensure that they do not play with the appliance.
- Pull out the plug from the power socket before cleaning or maintenance.
- Make sure that all pockets are emptied.
- Sharp and rigid items such as coins, nails, screws or stones etc. may cause serious damage to this machine.
- Pull out the plug and cut off water supply after the operation.
- Please check whether the water inside the drum has been drained before opening the door. Please do not open the door if there is any water visible.
- Pets and kids may climb into the machine. Check the machine before every operation.
- Glass door may be very hot during use.
- Keep kids and pets far away from the machine during use.
- Take care that power voltage and frequency shall be identical to those of washing machine.
- Do not use any socket with rated current less than that of washing machine. Never disconnect the power plug with wet hands.
- To ensure your safety, the power cord plug must be inserted into an earthed three-pole socket. Check carefully and make sure that your socket is properly and reliably earthed.
- Children of less than 3 years should be kept away unless continuously supervised.
- Children should be supervised to ensure that they do not play with the machine.
- Packing materials may be dangerous to children. Please keep all packing materials (plastic bags, foams etc) far away from children.
- The washing machine shall not be installed in the bathroom or very wet rooms as well as in the rooms with explosive or caustic gases.
- Make sure that the water and electrical devices must be connected by a qualified technician in accordance with the manufacturer's instructions and local safety regulations.
- Before operating this machine, all packages and transport bolts must be removed. Otherwise, the washing machine may be seriously damaged while washing the clothes.
- Before washing the clothes for the first time, the washing machine should be operated once without the clothes inside.
- The washing machine with single inlet valve only can be connected to the cold water supply. The washing machine with double inlet valves can be connected to the hot water and cold water supply.
- Your washing machine is only for home use and is only designed for the textiles suitable for machine washing.
- Flammable and explosive or toxic solvents are forbidden. Gasoline and alcohol etc. shall not be used as detergents. Please only select the detergents suitable for machine washing, especially for drum.
- Do not to wash carpets.
- Be careful of burning when washing machine drains hot washing water.
- Never refill the water by hand during washing.
- After the program is completed, Please wait for two minutes to open the door.
- Please remember to disconnect water and power supply immediately after the clothes are washed.
- Do not climb up and sit on top cover of the machine.
- Do not lean against machine door.
- Please do not close the door with excessive forces. If it is found difficult to close the door, please check if the excessive clothes are put in or distributed well.
- The household washing machine isn't intended to be built-in.

Cautions During Handling Machine

- 1 Transport bolts should be reinstalled when moving this appliance.
- 2 The accumulated water shall be drained out of the machine.
- 3 Handle the machine with care, do not lift with the machine door.

Usage Conditions and Restrictions

- Domestic use only: This appliance is intended for indoor household use only. It is not intended for industrial, commercial or trade use. Do not use it outdoors. Do not use it for anything other than its intended purpose (washing domestic quantities of laundry), and only use it as described in this manual.

Notes on Disposal:

This product should not be disposed with other household wastes. To prevent possible harm to the environment or human health from uncontrolled waste disposal, recycle it responsibly to promote the sustainable reuse of material resources. To return your used device, please use the collection systems or contact the retailer where the product was purchased. They return and can take this product for environmental safe recycling.

Notes on this Appliance:

- The maximum capacity of dry cloth for this washing machine is 6kg.
- The maximum/minimum inlet water pressure is 0.05-1MPa
- Net Dimensions: (W×D×H): 595mm × 495mm × 850mm
- Gross Dimensions: (W×D×H): 650mm × 575mm × 885mm
- Water Connection: Single cold water inlet.

Your Washing Machine

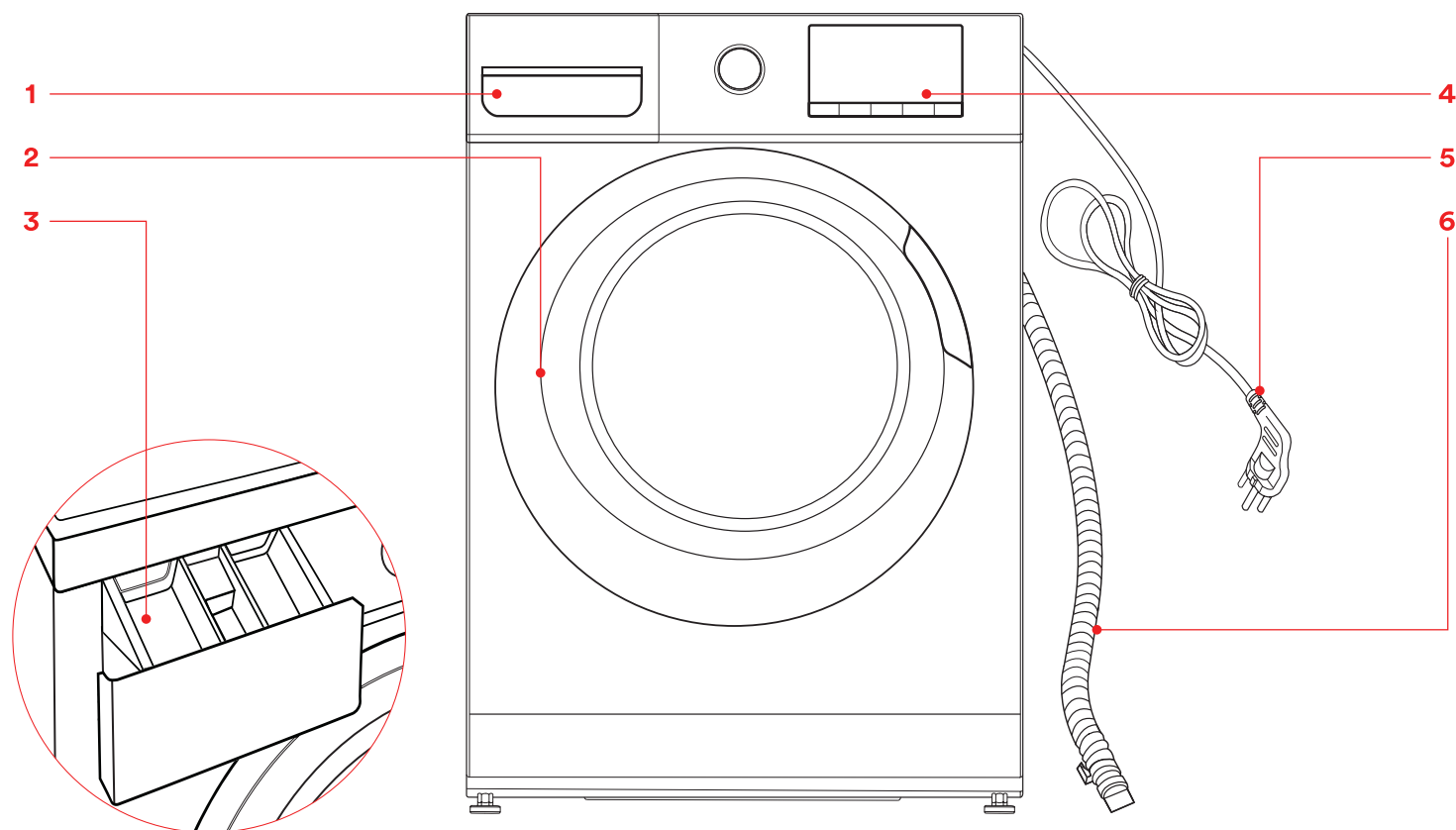

Component

- 1 Detergent Drawer
- 2 Door
- 3 Detergent Box
- 4 Control Panel
- 5 Power Plug
- 6 Outlet Hose

Accessories

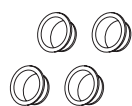

Transport hole plug



Hole plug (optional)

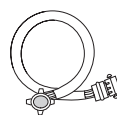

Inlet pipe, cold

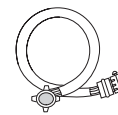

Inlet pipe, hot (optional)

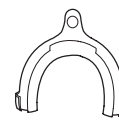

Outlet hose support (optional)

AFTER SALES SUPPORT

1300 11 43 57

support@residentiagroup.com.au

MODEL: SFLW6 | PRODUCT CODE: 10018 | 07/2019

Installation Instructions

Unpacking the washing machine

Unpack your washing machine and check if there is any damage during the transportation. Also make sure that all the items in the attached bag are received.

If there is any damage to the washing machine during the transportation, or any item is missing, please contact the local dealer immediately.

Disposal of the packaging materials

The packing materials of this machine may be dangerous to children. Please dispose of them properly and avoid contact with children. Please dispose of the related packing materials according to the relevant local regulations. Please do not throw the packing materials away together with other daily household waste.

Remove transport bolts (Fig. 1)

Before using this washing machine, transport bolts must be removed from the backside of this machine.

Please take the following steps to remove the bolts:

1. Loosen all bolts with spanner and then remove them.
2. Stop the holes with transport hole plugs.
3. Keep the transport bolts properly for future use.

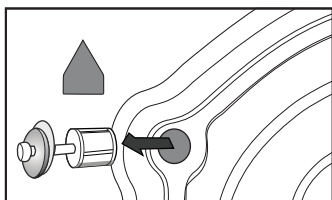

Fig. 1

Select the location

Before installing the washing machine, please consider the location for the following;

- Rigid, dry, and level surface (if not level, please make it level with reference to the following figure "Adjust Leg")
- Avoid direct sunlight
- Sufficient ventilation
- Room temperature is above 0 C
- Keep the washing machine away from combustible materials.
- Make sure that the washing machine does not sit on the power cord.
- Do not install the washing machine on carpet flooring.

Adjust Leg

1. When positioning the washing machine, please first check if the legs are closely attached to the cabinet. If not, please turn them to their original positions with hand or spanner and tighten the nuts with spanner.
2. After positioning the washing machine, press four corners on top cover of washing machine in sequence. If the washing machine is not stable when being pressed, this leg shall be adjusted.
3. Ensure the positioning status of washing machine. Loosen the lock nut with spanner and turn the leg with hand until it closely contacts with the floor. (Fig. 2) Press the leg with one hand and fasten the nut closely to the cabinet with the other hand.

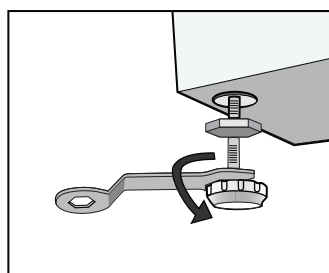

Fig. 2

4. After being locked properly, press four corners again to make sure that they have been adjusted properly. If it is still unstable, repeat Steps 2 and 3.
5. Ensure the machine is level, otherwise repeat steps 1-3.

Connect inlet pipe

Connect the inlet pipe as indicated in figure 3. For the model which has hot valve, please connect the hot valve to hot water tap. Energy will decrease automatically for some program.

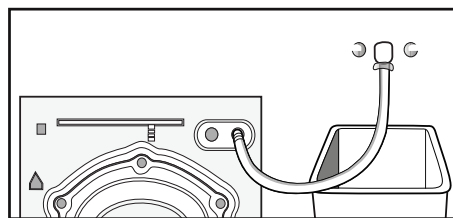

Fig. 3

Installation Instructions Continued

Install inlet pipe

1. Connect the elbow to tap and fasten it clockwise. (Fig. 4)
2. Connect the other end of inlet pipe to the inlet valve at the backside of washing machine and fasten the pipe tightly clockwise. Notes: after connection, if there is any leakage with hose, then repeat the steps to connect inlet pipe. The most common type of tap shall be used to supply water. If tap is square or too big, then standard tap shall be changed.

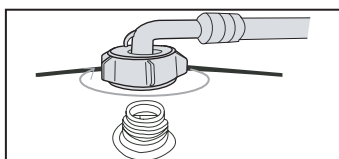

Fig. 4

Hole plug (Fig. 5)

This Hole plug is used to jam the hole on the back cabinet.

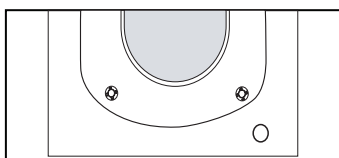
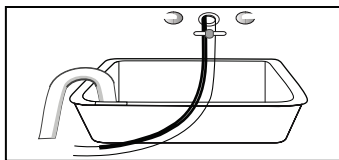

Fig. 5

Place outlet hose

There are two ways to place the end of outlet hose:

1. Put it beside the water trough. (Fig 6)
- 
- Fig. 6
2. Connect it to the branch drain pipe of the trough. (Fig 7)

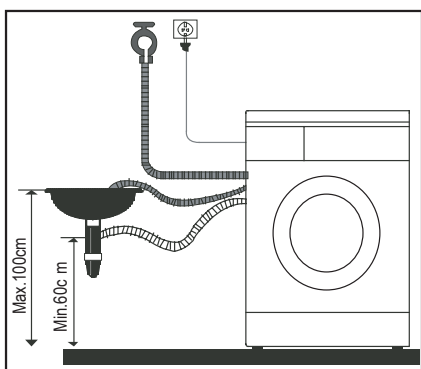

Fig. 7

Position outlet hose properly so that the floor will not be damaged by water leakage.

Note: If the machine has outlet hose support, please install it like the following pictures.

1. When installing outlet hose, fasten it tightly. (Fig. 8 + 9)

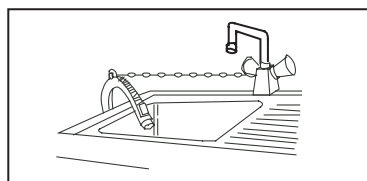

Fig. 8

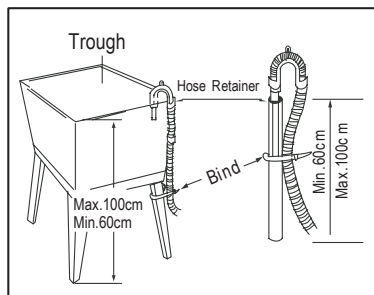

Fig. 9

2. If outlet hose is too long, do not force it into washing machine as it will cause abnormal noises.

Electrical Connection

As the maximum current through the unit is 10A when you are using its heating function, please make sure the power supply system (current, power voltage and wire) at your home can meet the normal loading requirements of the electrical appliances.

- Please connect the power to a socket which is correctly installed and properly earthed.
- Make sure the power voltage at your place is same to that in the machine's rating label.
- Power plug must match the socket and cabinet must be properly and effectively earthed.
- Do not use multi-purpose plug or socket as extension cord.
- Do not connect and pull out plug with wet hand.
- When connecting and pulling out the plug, hold the plug tightly and then pull it out. Do not pull power cord forcibly.
- If power cord is damaged or has any sign of being broken, special power cord must be selected or purchased from its manufacturer or service center for replacement.

Warning

1. This machine must be earthed properly. If there is any short circuit, earthing can reduce the danger of electrical shock. This machine is equipped with power cord, which includes plug, earthing wire at earthing terminal.
2. The washing machine shall be operated in a separate circuit from other electrical appliances. Otherwise, the safety switch may be tripped or the fuse may be burned out.

Washing Your Clothes

Checklist before Washing Clothes

Please read this section carefully to ensure proper use of the appliance and to avoid damaging your clothes.

Check first if clothes will be damaged by detergent

Place your liquid detergent on a spare white towel and put this in contact with a hidden part of your colour clothing.

Check if the towel takes on any of the colour.

- When washing scarves and other clothes that easily get decolorised, please wash them separately before washing.

Keep in Mind:

- Never leave clothes in the washing machine for prolonged periods of time, to avoid spotting and possible mould. The clothes also may get color changed or distorted if they are not washed according to the stated washing temperature. As for the stains on sleeves, collars and pockets, use the liquid detergent and wash it with a brush gently before washing.

Clothes that cannot be washed

Clothes that may get distorted being soaked in water or put through the washing machine cycle:

- Ties, waistcoats, western-style clothes, outer garments etc. may have obvious shrinkage if being immersed in water; the decolorized clothes such as blended spinning clothes of artificial fibre etc.
- Wrinkle-style clothes, embossed clothes, resin clothes etc. may get distorted when being immersed in water. Among cotton and wool materials, the clothes that get easily distorted are wrinkle-style silk, fur products and fur decorations;
- Clothes with decoration, long dress and traditional clothes etc are the products to get decolorized easily.
- Please do not wash the clothes without material labels and washing requirements.
- Never wash the clothes stained with the chemicals such as gasoline, petroleum, benzene, paint thinner and alcohol.

Please pay attention to detergents

- “Low bubble” detergent or washing powder or washing powder special for drum washing machine shall be selected according to fibre types (cotton, synthetic fibre, soft products and wool products), colors, washing temperatures, dirtiness and types. Otherwise, excessive bubbles may be generated and overflowed out of the drawer.
- Bleacher belongs to alkali type and can damage clothes, so it is suggested to use as little as possible.
- Powder detergents can easily leave the residues in the clothes so as to generate the bad smell, so they shall be sufficiently rinsed.
- Detergent can not easily get dissolved completely if there is too much detergent or water temperature is rather low. It can remain in clothes, pipes and washing machines to pollute the clothes.
- Washing shall follow the weight of clothes, dirtiness, local water hardness as well as the recommendations from the detergent manufacturers. Please consult the water company if you are not clear of water hardness.

Notes: Keep detergents and additives in a safe and dry place, away from children.

Please remove any items from all pockets prior to washing, otherwise your washing machine may be damaged.

Washing Your Clothes Continued

For the clothes to be washed, they are classified according to the following characteristics:

The symbol types of care labels: the clothes to be washed are classified into cotton, blended fibre, synthetic fibre, silk, wool and artificial fibre.

- **Color** White and colorful colors shall be identified. All new colorful articles shall be washed in a separately.
- **Size** Articles of different sizes should be washed together to increase the washing effects.
- **Sensitivity** Soft articles shall be washed separately. As for new pure wool textiles, curtains and silks, the soft washing procedure shall be selected. Check the labels in all washing articles.

The clothes shall be sorted before being put into washing machine. As for the curtains with hooks, the hooks shall be removed before being washed. The decorations on the clothes may damage the washing machine. As for the clothes with buttons or embroideries, they shall be turned over before being washed.

- **Fasteners** Zips shall be zipped closed and buttons or hooks shall be fixed. The loose band or ribbon shall be bound together.

It is suggested to put bras into the pillowslip with zip or buttons sealed to prevent the steel wire from popping out of bras into the drum and damaging the machine. Especially delicate textiles such as laced curtains, straight jackets, small articles (tight socks, handkerchiefs, ties etc.) shall be put into string bag for washing. When washing single, heavy items such as Turkish towels, jeans, jackets etc., it may cause the machine to become off balance and sound the error alarm. Therefore it is suggested to add one or two more clothes to be washed together so that draining can be done smoothly.

Clean dust, stains and pet hairs from clothes

The clothes may be damaged and disturb washing effects during the friction between dusts, stains and clothes.

To protect baby skin

Baby articles (baby clothes and towels) including nappies shall be washed separately. If they are washed together with the adults' clothes, they may be infected. Rinsing times shall be increased to ensure the thorough rinsing/cleaning and to remove any detergent residue.

Note: It is suggested that the parts that are easily stained such as white sockets, collars and sleeves etc. shall be hand washed before being put into washing machine to achieve more ideal washing effects. Please use powder or liquid detergents. The residues of the soap could remain in the gaps of the clothes if soap is used.

Confirm the washing capacity

Do not overload the machine. Please see following table outlining capacity requirements for each material:

FIBRE TYPE	MAX. LOADING CAPACITY (6.0KG)
Cotton	6.0kg
Synthetic	3.0kg
Wool	2.0kg
Delicate	2.5kg

The clothes which easily get fuzzed shall be turned over for washing. The clothes which easily get fuzzed shall be washed separately; otherwise the other articles can be stained with dust and thrum etc. Preferably, black clothes and cotton clothes shall be washed separately because they can easily get stained with the thrums of other colors when being washed together. Please check before washing.

Do not wash

Waterproof materials (ski suits, outside napkin pads, curtains). With these types of materials, water cannot soak through easily so avoid washing. This may cause abnormal function, incorrect drainage or vibration within your washing machine and may harm your clothing.

Quick Start Guide

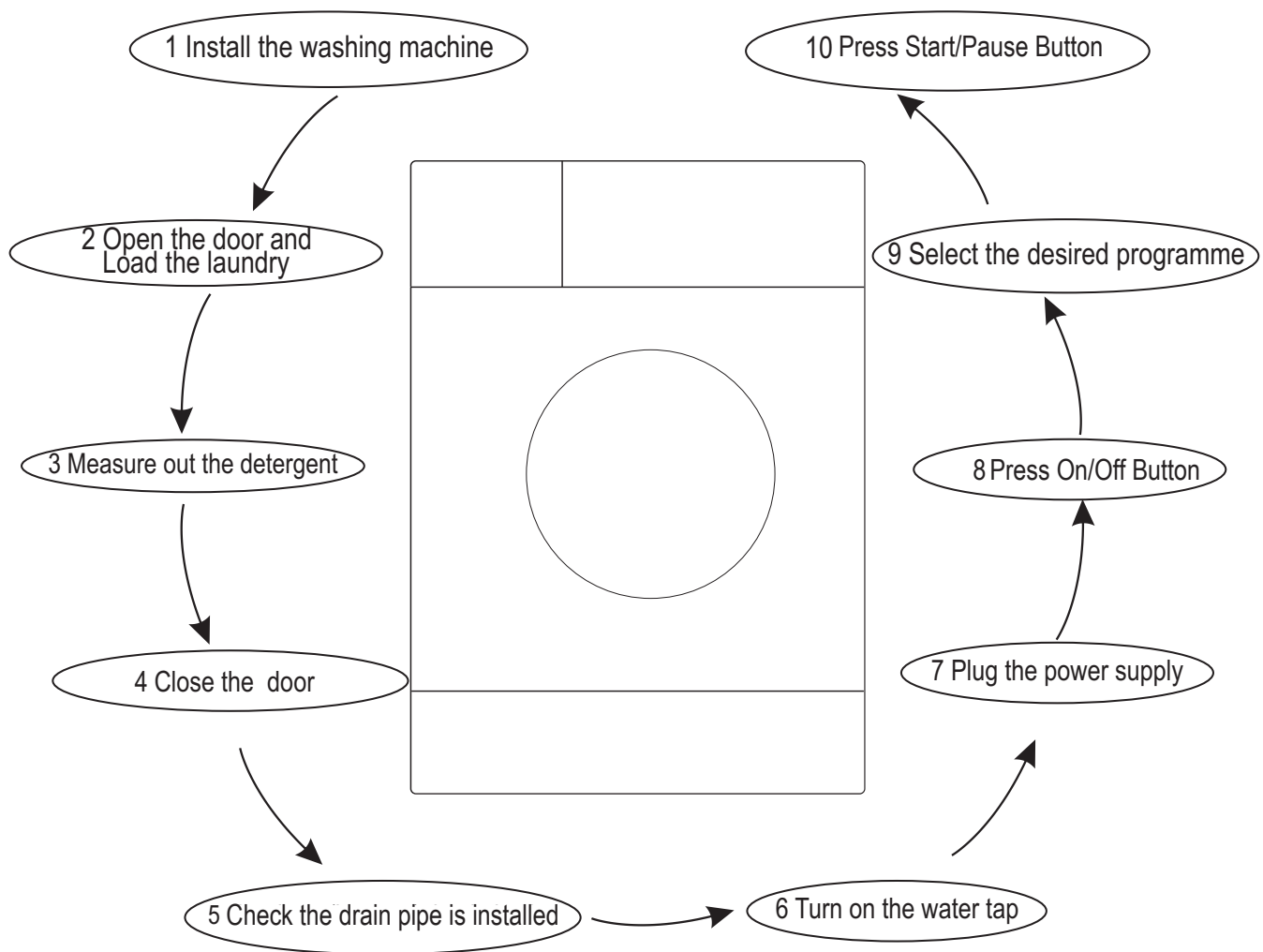

After washing:

1. After washing, the washing machine will beep to advise you the cycle is complete
2. Close the water tap
3. Press the On/Off button and pull out the power plug

Controls

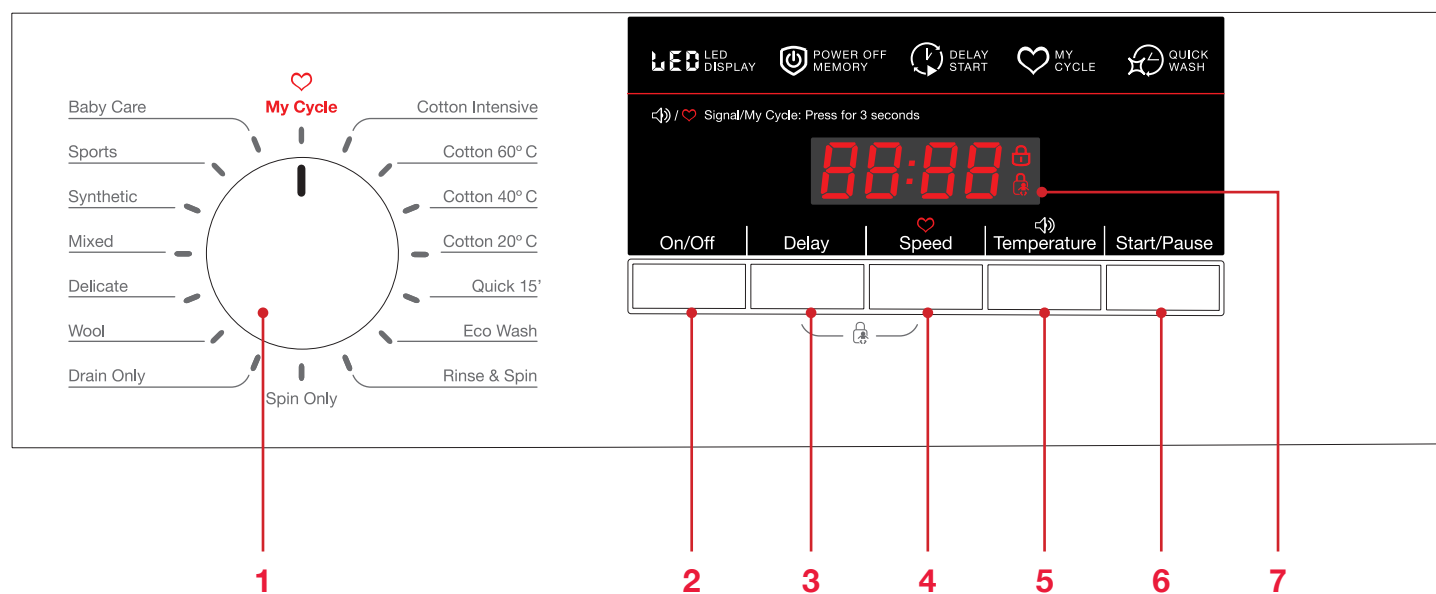

- KEY**
1. Program Selection knob
 2. On/Off button
 3. Delay button
 4. Speed button
 5. Temperature button
 6. Start/Pause button
 7. LED screen display

Program Selection knob

There are 16 types of washing selection functions in display. They include:

- **Cotton intensive:** With the corresponding temperature selections: 20, 30, 40, 60, 90° C, Cold
- **Cotton 60° C:** Cotton 40° C; Cotton 20° C;
- **Rapid 15':** 20, 30, 40° C, Cold
- **Eco Wash:** 20, 30, 40° C, Cold
- **Rinse & Spin**
- **Spin only**
- **Drain only**
- **Wool:** 20, 30, 40° C, Cold
- **Delicate:** 20, 30° C, Cold
- **Mixed:** 20, 30, 40° C, Cold
- **Synthetic:** 20, 30, 40, 60° C, Cold
- **Sports:** 20, 30, 40° C, Cold
- **Baby care:** 20, 30, 40, 60, 90° C, Cold
- **My Program:** customised program of your choosing

Notes:

1. The Control panel line chart is for your reference only. Please refer to real product as standard.
2. The Control panel could be changed without written notice. Please visit the website of Washing Machine or call up the service line for consultation.

Operating Your Washing Machine

Washing Clothes for the first time (Fig. 10)

Before washing clothes, the washing machine should be operated once without clothes, as follows:

1. Connect power source and water.
2. Put a little detergent into the box and close it.
3. Press the button "On/Off".
4. Press the button "Start/Pause".

The drawer is separated as follows:

- I Pre-detergent or washing powder
- II Main detergent
-  Washing additive/Fabric softener

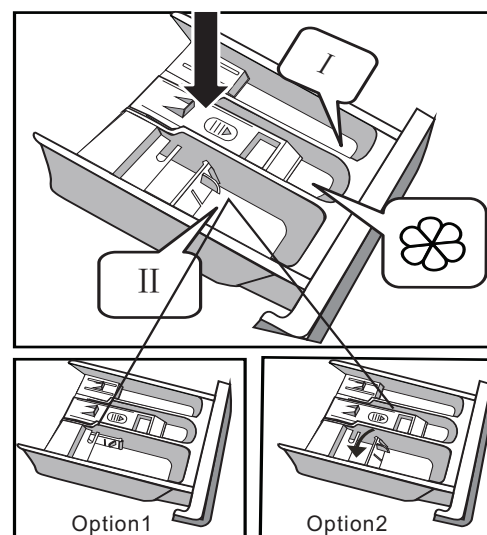



Fig. 10

Put detergent into washing machine (Fig. 10)

1. Pull out the drawer.
2. Fill pre-detergent into Case I (when necessary).
3. Fill detergent into Case II.
 - Option 1: detergent (powder)
 - Option 2: (liquid)
4. Fill softener into Case  (when necessary).

Notes: Please choose suitable type of detergent for the various washing temperature to get the best washing effect with less water and energy consumption.

Startup washing machine

Connect the power. Check if water pipes are connected properly. Open the tap completely. Put in the clothes to be washed and fill in the detergent and/or softener. Then press the "On/Off" button. Select the proper procedures and functions and press the button "Start/Pause".

Select the procedure

The proper washing procedures shall be selected according to the types, quantities, and dirtiness of the clothes to be washed in combination with the following washing temperature table.

90 °C	Stubborn stains, pure white cotton or linen (for example: coffee table cloths, canteen table cloths, towels, bed sheets)
60 °C	Moderately tough stains, colours, cotton and synthetic articles with certain decolorising degree (for example: shirts, pajamas, pure white linen)
40 °C, 30 °C, 20 °C, Cold water	Everyday dirty clothes (for example: synthetic and wool)

Operating Your Washing Machine Continued

First:

Turn the rotary switch to select the corresponding procedures according to the types of materials you are washing.

Second:

Select the proper temperature according to the dirtiness. Generally, the higher the temperature is, the more the power is consumed.

Last:

Select the proper revolution spin speed. The higher the revolution spin speed is, the drier the textiles are spun, but the noise will also be increased.

PLEASE NOTE: to protect the clothes, select a lower revolution spin speed for delicate items. The main washing procedures depend on the types of the clothes to be washed as follows:

- Cotton:

You can select this procedure to wash the daily washable clothes. The washing period is quite long and is quite a strong wash program. It is recommended for washing daily cotton articles, for example: bed sheets, quilt covers, pillowcases, gowns, underwear etc.

- Cotton 60/40/20°C:

You can select this procedure to wash daily clothes. The washing period is quite long with quite strong also. The temperature's default is 60°C/ 40°C/20°C

- Rapid 15':

This procedure is suitable for washing few and not very dirty clothes for 15mins'.

- ECO Wash:

As for few light dirty clothes, the maximum temperature of washing is limited to 40°C, and saving more energy.

- Rinse & Spin:

Separate Rinse & Spin Procedure.

- Spin Only:

Separate spin only procedure. Soap water or rinse water shall be drained out before spinning.

- Drain Only:

Separate Drain only Procedure.

- Wool:

You can select this procedure to wash the wool textiles labeled with "Machine Wash". Please select the proper washing temperature according to the label on the articles to be washed. Furthermore, the proper detergent should be selected for wool textiles.

- Delicate:

You can select this procedure to wash your delicate clothes. It is a gentler wash with slower spin speed compared with the procedure "Synthetic".

- Mixed:

You can select this procedure to wash tougher clothes, that require more time to wash. It is used for daily clothes made of cotton, such as sheets, pillowcases, bathrobes and underwear.

- Synthetic:

You can select this procedure to wash the quite delicate clothes. The procedure is shorter compared with that for cottons and the wash is quite gentle. It is recommended to wash synthetic articles, for example: shirts, coats. As for curtains and laced materials, the "Synthetic" cycle should be selected. When washing knitted materials, reduce the volume of detergent used due to the loose nature of the clothes which create foaming bubbles more easily.

- Sports:

You can select this procedure to wash your activewear.

- Baby Care:

You can select this procedure to wash your baby's clothes, it washes the baby's clothes and the rinse performance is better to protect the baby skin.

- My Cycle:

Press Speed button for 3sec. once you have selected your preferred wash settings for my cycle to save the memory of your favourite cycle.. The default my cycle is cotton.

Operating Your Washing Machine Continued

The main function can be selected as follows:

- Prewash:

The Prewash function can get an extra wash before main wash.

- Express Wash:

The function can decrease the washing time.

- Extra Rinse:

The laundry will undergo extra rinse if you select it.

- Delay:

Delay function can be set with this button, the delaying time is 0-24H. Set the delay function:

1. Select a program;
2. Press the Delay button to choose the time;
3. Press Start/Pause to commence the Delay operation.

Cancel the Delay function: Press the Delay button until the display shows 0H. It should be pressed before starting the program. If the program is already started, you should press the On/Off button.

Notes: If there is any break in the power supply while the machine is operating, a special memory stores the selected program and when the power is restarted, press the Start/Pause button and the remaining time will continue.

Child Lock

To avoid children from operating the washing machine during use, you can select this function, In this case, all other buttons except On/Off button will not work, in this state, the machine will only power off when you press the "ON/OFF" key. Once the "ON/OFF" button is selected again, the machine will remember the child lock and the program which was selected before the machine was powered off. Press the "Temp" and "Speed" buttons together for 3 seconds during the running procedure, the buzzer will beep, the Start/Pause button as well as the selector switch are locked. Press the two buttons for 3 seconds together again and the buzzer will beep to release the child lock.

- Turning off alarm noise:

This is an additional function on your appliance. After deactivating the alarm noise function, the noise will no longer sound.

After starting the machine, press the "Temp" button for 3 seconds and you will hear a beep, then the alarm noise will turn off. To restart the alarm noise function, press the "Temp" button again for 3 seconds. The setting will be kept until the next reset.

Warning: After deactivating the alarm noise function, the sounds will not be activated any more.

- Bubble Removal Function:

Bubble Check Function: Residual bubbles will form when there is excessive detergent, which will affect wash and rinse programs. This function will check for additional bubbles automatically and the bubble removal procedure will be added automatically to remove bubbles when excessive bubbles are found.

Operating Your Washing Machine Continued

Washing Procedures

Procedure Description	Load(kg)	Detergent Box			Default Temp.(°C)	Default Time (Min)	Default Speed (rpm)
	6.0	Case I	Case II	Softener Case	6.0	6.0 at 1200rpm	1200
Cotton Intensive	6.0	×	●	○	40	1:58	1000
Cotton 60°	6.0	×	●	○	60	4:36	1200
Cotton 40°	6.0	×	●	○	40	1:25	1200
Cotton 20°	6.0	×	●	○	20	1:13	1000
Quick 15'	2.0	×	●	○	Cold	0:15	800
Eco Wash	2.0	×	●	○	30	1:06	800
Rinse&Spin	6.0	×	×	○	—	0:31	1000
Baby Care	6.0	×	●	○	60	1:39	1000
Sports	3.0	×	●	○	40	1:19	800
Synthetic	3.0	×	●	○	40	1:33	1200
Mixed	6.0	×	●	○	40	1:13	1000
Delicate	2.5	×	●	○	30	1:00	600
Wool	2.0	×	●	○	40	1:06	400
Drain Only	—	×	×	×	—	0:01	0
Spin Only	6.0	×	×	×	—	0:12	1000

- Means must
- Means optional
- × Means not necessary

Notes

The parameters in this table are only for user's reference. The actual parameters maybe different with the parameters in above mentioned table.

Energy test program: Cotton 60° C, Speed: the highest speed; Other as the default. Half load for 6.0Kg machine: 3.0kg.

“Cotton 60” is the “standard cotton 60” program tested for the appropriate standards and the washing program to which the information in the label relates, this wash is suitable to clean normally soiled cotton laundry and is the most efficient program in terms of combined energy and water consumptions for washing that type of cotton laundry, the actual water temperature may differ from the declared cycle temperature.

Maintenance

Before undertaking any maintenance, please pull out the power plug or disconnect power and close the water tap.

WARNING!

- Do not use any solvents, as they may damage the machine, cause toxic gases or cause an explosion.
- Never use water to sprinkle and wash the washing machine.
- It is forbidden to use detergents containing PCMX to clean the washing machine.

Cleaning & Maintenance of Washing Machine Cabinet

Proper maintenance on the washing machine can extend its working life. The surface can be cleaned with diluted non-abrasive neutral detergents when necessary. If there is any water overflow, use a wet cloth to wipe it off immediately. Avoid the use of sharp objects.

Notes: formic acid and its diluted solvents or equivalent are forbidden.

Clean Internal Drum

Rust left inside the drum by metal articles should be removed immediately with chlorine-free detergents. Never use steel wool.

Defrosting a Frozen Washing Machine

When the temperature drops below zero degrees Celsius and your washing machine is frozen, you may:

1. Disconnect the power supply from the washing machine.
2. Wash the tap with warm water to loosen inlet pipe.
3. Remove inlet pipe and immerse it in warm water.
4. Pour warm water into washing drum and wait for 10 minutes.
5. Reconnect inlet pipe to the tap and check whether the inlet and outlet hoses are working normally.

Note: when the washing machine is reused, make sure the ambient temperature is above 0°C

Anti-freeze

If your washing machine is in a room where it can get frozen easily, please drain the remaining water inside drain pipe and inlet pipe thoroughly.

Remove the remaining water in inlet pipe:

1. Turn off the water tap.
2. Screw off the inlet pipe from tap and put its end into a container. (Fig. 11)
3. Start up any procedure except single Wash or Drain procedure. Any water will be drained out of inlet pipe for about 40 seconds.
4. Reconnect the inlet pipe to tap.

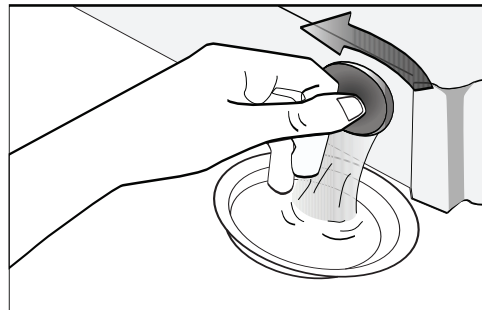

Fig. 11

Remove the remaining water in drain pump

WARNING!

To avoid burning, it shall be done after the hot water inside the machine cools down.

Maintenance Continued

Clean detergent box and grooves (Fig. 12)

Clean detergent drawer and grooves

1. Press down the arrow location on softener cover inside the drawer.
2. Lift the clip up and take out softener cover and wash all grooves with water.
3. Restore the softener cover and push the drawer into position.

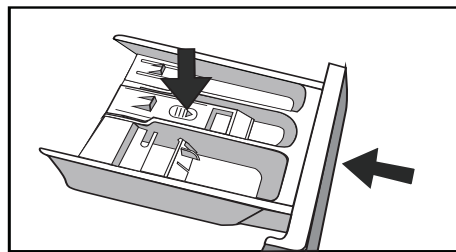
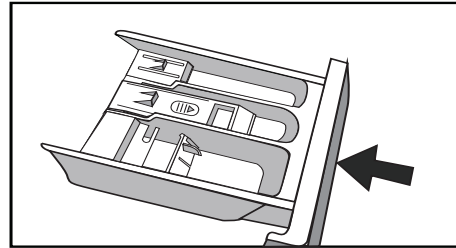
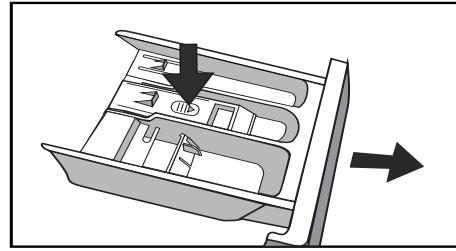

Clean inlet filter

The inlet filter should be cleaned if there is insufficient water filling when the tap is opened.

Clean the tap filter:

1. Turn off the tap.
2. Select any procedure except “Wash” or “Drain” procedure.
3. Press the “Start/Pause” button and keep the procedure running for about 40 seconds.
4. Remove the inlet pipe from the tap.
5. Use water to wash the filter.
6. Reconnect the inlet pipe.

Washing the filter in washing machine (Fig. 13)

1. Screw off the inlet pipe from the backside of the machine.
2. Pull out the filter with long nose pliers and reinstall it back after being washed.
3. Reconnect the inlet pipe.
4. Open the tap and make sure there is no water leakage.
5. Close the tap.

Note: Generally, the tap filter is washed first and then the filter in washing machine will be washed.

If only the filter in washing machine is washed, then the steps 1~3 in cleaning the tap filter shall be repeated.

Fig. 12

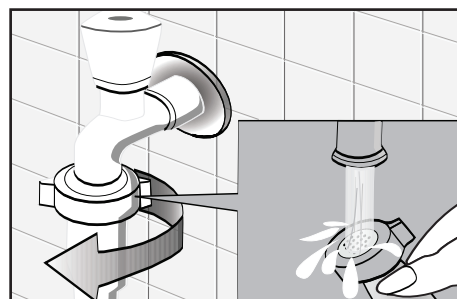
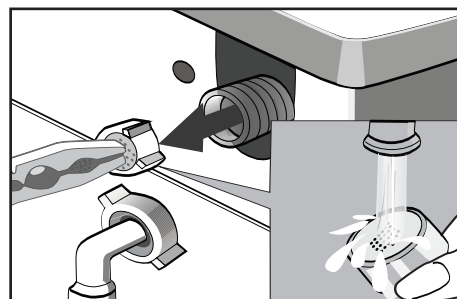
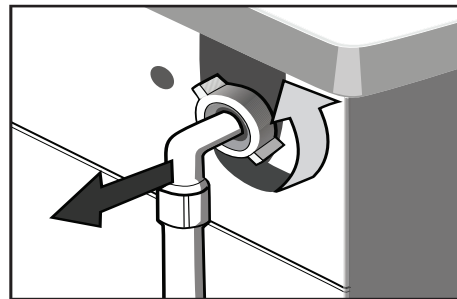

Fig. 13

Maintenance Continued

WARNING!

Pull out the power plug to avoid electrical shock before washing.

After using the washing machine, pull out the power cord and close the door tightly to avoid injuring people.

Remove foreign matters Drain Pump Filter:

The drain pump filter can filter lint and other small foreign objects from the washing machine. Clean the filter periodically to ensure normal operation of washing machine.

WARNING!

Depending on the dirtiness of each cycle and the frequency of the cycles, you must inspect and clean the filter regularly.

The pump should be inspected if the machine does not empty and/or spin;

The machine makes an unusual noise during draining due to objects such as safety pins, coins etc. blocking the pump.

Proceed as follows:

1. After the power is disconnected, use hand to open the filter cover. (Fig. 14)
2. Turn the filter to open as shown and take out any foreign matter. (Fig. 15)
3. Reinstall each part back after foreign matter is removed. (Fig. 16)

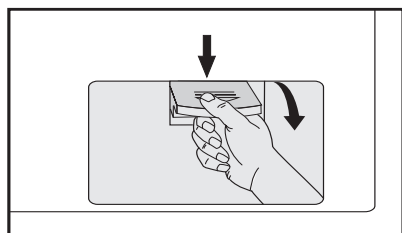

Fig. 14

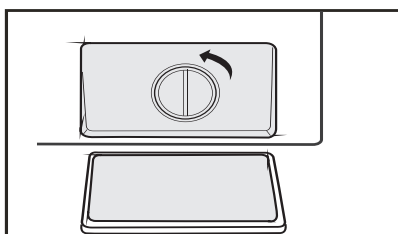

Fig. 15

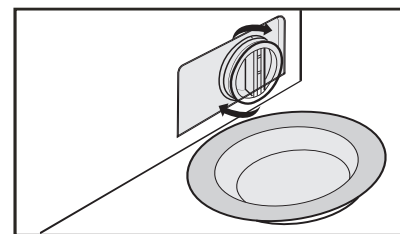

Fig. 16

WARNING!

When the appliance is in use and depending on the program selected there can be hot water in the pump. Never remove the pump cover during a wash cycle, always wait until the appliance has finished the cycle, and is empty. When replacing the cover, ensure it is securely tightened









Troubleshooting

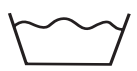
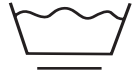
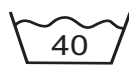









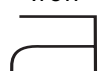

Troubles	Reason	Solution
Washing machine cannot start up		Check if the door is closed tightly. Check if power plug is inserted well. Check if water supply tap is opened. Check if button "Start/Pause" is pressed. Check if button "On/Off" is pressed.
Door cannot be opened	Machine's safety protection design is working.	Disconnect the power.
Heating fault	NTC is damaged and heating pipe is aging.	Wash clothes using cold wash Contact .support promptly
Water leakage	The connection between inlet pipe or outlet hose and tap or washing machine is not tight. Drain pipe in the room is blocked.	Check and fasten water pipes. Clean up outlet hose and ask a specialized person to repair it when necessary.
Water is overflowing from the bottom of the machine	The inlet pipe is not connected firmly. Outlet hose is leaking.	Fix the inlet pipe. Replace the drain hose.
Indicator or display does not light.	Power is disconnected. PC board has problems. Harness has connection problem.	Check if the power is shut down and power plug is connected correctly. If not, please call support
Detergent residues in the dispenser	Washing powder is wet or clogged	Clean and wipe the dispenser drawer. Use liquid detergents or the detergents special for drum
Washing effects inefficiently	The clothes are too dirty. Insufficient detergent quantity.	Select a proper procedure. Add the proper detergent quantity according to the instructions in detergent package.
Abnormal noise / vibration		Check if the fixing (bolts) has been removed. If cabinet is installed on a solid and level floor. Check if there are any metal objects inside. Check if the legs in the washing machine are adjusted level.







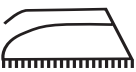

Display LED	Description	Reason	Solution
<i>E30</i>	Door lock problem	Door is not closed properly.	Restart after the door is closed.
		Please call up service line if there are still troubles.	
<i>E10</i>	Water inlet problem while washing	Tap is not opened or water flows too slowly. Inlet valve filter is blocked. Inlet pipe is twisted. If water is not supplied	Open the tap or wait till the water supply becomes normal. Check inlet valve filter. Straighten the water pipe Check the other taps in the room.
		Water inlet Please call support if problems persistwashing	
<i>E21</i>	Drain problem while washing	Outlet hose is blocked, or twisted. Drain pump is blocked	Wash and straighten outlet hose. Wash drain pump filter
		Please call support if problems persist	
Please call support for all other matters.			

Care Label

The label and icons on the fabric can assist you to choose the best ways to launder your clothes:

<p>Normal wash</p>  <p>Gentle wash</p> 	 <p>Warm wash (max 40°C)</p>	<p>Hand wash</p>  <p>Do not wash</p> 	<p>Bleach</p>  <p>Do not bleach</p> 	<p>Chlorine bleach may be used</p>  <p>Chlorine bleach not be used</p> 	<p>Tumble dry. Medium (max 150°C)</p>  <p>Tumble dry. Low heat (max 110°C)</p> 
---	--	---	--	---	--

<p>Iron</p>  <p>Do not iron</p> 	<p>Cool iron(max 110 °C)</p>  <p>Warm iron. medium (max 150°C)</p> 	<p>Dry clean</p>  <p>Do not dry clean</p> 	<p>Dry clean normal cycle with any solvent</p>  <p>Dry clean normal cycle petroleum solvent only</p> 	<p>Tumble dry normal</p>  <p>Dry flat</p> 	<p>Drip dry</p>  <p>Hang to dry /Line dry</p> 
--	--	--	---	--	--

<p>Iron with cloth</p>  <p>Steam Iron</p> 	<p>Dry after wash</p>  <p>Line Dry in shade</p> 	<p>Warmly dry clean</p>  <p>Do not tumble dry</p> 	 <p>Line Dry</p>	 <p>No Wring</p>	 <p>No machine wash</p>
---	---	---	---	--	---

ELECTRICAL WARNING!

To avoid fire, electrical shock and other accidents, please remember the following reminder:

- Only the voltage indicated on the power label can be used. If you are not clear of the voltage at home, please contact the local power company.
- When you are using the heating function, the maximum current through the washing machine will reach 10A. Therefore, please make sure the power supply units (current, voltage and cable) can meet the normal load requirements for the machine.
- Protect the power cord properly. The power cord should be fixed well so that it will not trip people or cause any damage. Special attention should be paid to the socket. It should be plugged into the socket easily and attention shall be paid to the plug location.
- Do not overload the wall-mounted socket or use extension cable. Overloading of the wiring may cause fire or electrical shock. Do not pull out the power plug with wet hands.
- To ensure your safety, the power plug should be inserted into an earthed three-pole socket.

Carefully check and ensure that your socket is properly and reliably earthed.

Technical Data

RATING LABEL

STIRLING® **MODEL: SFLW6**

6.0kg Front Load Washing Machine

Serial Number:
Rated Capacity: 6.0kg
Rated Voltage: 220–240VAC~
Rated Frequency: 50Hz
Rated Power: 2050W
Max Current: 10A
Net Weight: 61kg
Water Pressure: 0.05–1MPa
Grade of Waterproof: IPX4
Made in China

AUS 1300 11 4357

support@residentiagroup.com.au

E2447

3
YEAR IN HOME
WARRANTY

W²

Residentia Group PTY LTD
 Barcode: 4088700055397
 07/2019 PLU: 10018 V1.0

ADDITIONAL INFORMATION FOR STANDARD PERFORMANCE TESTING

(AS/NZS 2040.1:2005+Amdt1-2007+Amdt2-2009)

1. Water connections: Cold water connection
2. Water supply pressure: 320 kPa
3. Warm wash Program: Cotton 60° C Display: 4:36
Cold wash program: Cotton Cold (no temperature display is cold wash)
4. Detergent type: Drum detergent
5. Detergent quantity: Default
6. Adding detergent:
The detergent is dissolved and added as Paragraph B7.3 of AS/NZS 2040.1
The detergent shall be dissolved in 1 L of water
7. Anti-sudsing agent: Max
8. Test load mass: 6.0kg
9. Water consumption: 61L
10. Test Voltage: 220-240V~, 50Hz

AFTER SALES SUPPORT

AUS 1300 11 43 57

support@residentiagroup.com.au

MODEL: SFLW6 | PRODUCT CODE: 10018 | 07/2019



 **STIRLING**[®]

6kg Front Load Washing Machine

Repair and Refurbished Goods or Parts Notice

Unfortunately, from time to time, faulty products are manufactured which need to be returned to the Supplier for repair.

Please be aware that if your product is capable of retaining user-generated data (such as files stored on a computer hard drive, telephone numbers stored on a mobile telephone, songs stored on a portable media player, games saved on a games console or files stored on a USB memory stick) during the process of repair, some or all of your stored data may be lost.

We recommend you save this data elsewhere prior to sending the product for repair.

You should also be aware that rather than repairing goods, we may replace them with refurbished goods of the same type or use refurbished parts in the repair process.

Please be assured though, refurbished parts or replacements are only used where they meet ALDI's stringent quality specifications.

If at any time you feel your repair is being handled unsatisfactorily, you may escalate your complaint. Please telephone us on 1300 11 43 57 or write to us at:

Residentia Group
165 Barkly Avenue, Burnley
VIC 3066 Australia

Email: support@residentiagroup.com.au

Helpline hours of operation:
Mon–Fri
9:00 AM - 5:00 PM





Warranty returns

Should you for any reason need to return this product for a warranty claim, make sure to include all accessories with the product.

Product does not work?

If you encounter problems with this product, or if it fails to perform to your expectations, make sure to contact our After Sales Support Centre on 1300 11 4357.

For an electronic copy of this manual, go to www.stirlingappliances.com.au and download a copy.

This page
is intentionally
left blank

This page
is intentionally
left blank

